

CHAPTER 33

Contactors and Relays

A relay is an electro magnetically operated switch. Generally, a relay is an electromagnetic device, within which an electro-magnet is fixed to cause controlled movement either by magnetic attraction or magnetic repulsion. Other hardware galvanically isolated is attached to the moving magnetic portion of the component, such as relay contacts, which causes switching of electrical circuits.

Differentiation between a contactor (or relay), a circuit breaker, and a mechanical switch is as follows:

A *relay* is an electromagnetic device for remote or automatic control that is actuated by variations in conditions of an electric circuit and which, in turn, operates other devices (such as contacts) in the same or more often, a different (isolated) higher power circuit. A high power-handling relay is termed a contactor.

A *circuit breaker* is a switch that automatically interrupts an electric circuit under an infrequent abnormal condition; e.g., a fault condition such as an overload or rupture of either high voltage or high current or both. A *contactor* is a circuit breaker without short circuit operation capability, whereas a *disconnecter* only provides distance isolation.

A *mechanical switch* is a device for making, breaking, or changing the connections in an electrical circuit, usually mechanical and operated manually.

33.1 Mechanical requirements for relay operation

A relay comprises a coil (of insulated copper wire), a plunger, and contacts, all housed together within a case or body. Electrically energising the coil creates a magnetic field, in the core and yoke, that moves the plunger. The movement of the plunger causes a moving low resistance contact to move toward (or away from) a non-moving fixed contact. It is the coming together of these contacts (make) or separation of them (break) that has the effect of switching. The fixed contact may be mounted on compliant springs or fixed brackets. The movable contact (single throw, *ST*) is mounted on some form of spring that can be deflected or on a hinge arm. The force and travel needed for such motions serve a number of purposes. Relay coils are wound for a particular voltage, commonly 24V dc, a safe voltage for control automation, 115V ac is often used in North America and 230V ac is found in EU systems. A coil will activate its plunger as the voltage increases from zero to its normal rated level, *nominal voltage*, and this is known as the *pull-in voltage* (often around 80% of nominal). As power is removed from the coil the plunger returns to its rest position as the voltage drops below the *drop-out voltage* (often around 20% of nominal).

Before the armature is actuated for a relay with double throw *DT* contacts, the movable contacts must be held against the normally closed fixed contacts by a spring force sufficient to establish good electrical contact. When the armature is actuated, a number of actions happen. Each movable contact is pushed or pulled away from the corresponding, normally closed, fixed contact. This requires a force sufficient to overcome one or more springs. Also, there is friction between the contacts if they slide before they separate, and in any actuator pivots. As contact motion takes place, various springs deflect according to Hooke's law, and inertial forces must be overcome.

After the accelerated motion of contact transfer, the movable contact impacts and decelerates as it reaches its normally open fixed contact. Both contacts must deflect or deform to some degree as the desired contact force builds up. Over-travel can be employed to provide contact cleaning action, through sliding, and to compensate for contact wear or erosion. When there are multiple sets of contacts (poles), allowance is made for manufacturing tolerances for the various stages of travel required for and their associated spring forces.

The word *normally (N)* refers to a de-energized relay condition (no electrical power into the coil). The subsequent word *open (O)* or *closed (C)* refer to the position of the contacts in a de-energized condition, viz., *normally open NO* or *normally closed NC*.

33.2 Relay contacts

33.2.1 Contact characteristics

Contact characteristics that affect switching performance are:

- Electrical conductivity
- Thermal conductivity
- Hardness, limit of elasticity: Young's Modulus
- Resistance to erosion, welding or electrical sticking, cold welding, mechanical wear, oxidation, and atmosphere contamination (chemically active).
- Tendency to bounce on impact, gaseous absorption, catalytic polymerization of hydrocarbons, metal transfer at contact closure and arcing at opening.

Besides the physical and chemical properties of the contact metal, there are some geometrical and dynamic considerations:

- Shape of contacts
- Force between contacts
- Amount of slide or *wipe*
- Amount of rolling or twisting motion
- Supporting structure resiliency and its tendency to enhance or inhibit bounce or chatter.

When contacts meet, the metal at the point of the contact deforms until the actual touching area supports the contact force and provides metal-to-metal contact, unless some foreign material interferes. Deformation is at the point of contact, either in the elastic or plastic modes, contributes to the amount of contact bounce. Microscopically, many actual points of contact (often referred to as *a-spots*) form the electrical conductor and carry the current. The contact interface is also subject to mechanical abrasion and metal *galling* as it rubs, and *cold welding*. The surface absorbs a monomolecular layer of volatile molecules in direction proportion to the molecular weight and concentration of the volatile material and the ambient pressure, and inversely proportional to the temperature. Water vapour is also a common substance forming thin absorbed layers.

Each metal has particular pertinent chemical properties. Silver and its alloys, which have excellent electrical and thermal characteristics, tend to combine chemically with gaseous compounds of sulphur, the halogens (fluorine, chlorine, bromine, and iodine), and silicones, to form high electrical resistance, in the form of hard coatings. Unlike other noble metals (gold, platinum, rhodium, iridium, palladium, and ruthenium, all of which are used in contacts), silver has no catalytic effect (polymerization) in the sense of changing, under sliding pressure, the absorbed hydrocarbon molecules into a solid hydrocarbon material. Arcing, however, can cause the precipitation of solid carbon or carbonaceous products, usually in a ring around the actual point of contact.

Molybdenum, tungsten, nickel, and mercury are used alone or as alloying or sintering ingredients. Cadmium oxide, tungsten carbide, tin, magnesium, and carbon are sometimes added to silver to inhibit sticking or welding, particularly in high-current relays or contactors. When contacts are within an inert gas, like nitrogen, other contact materials are applicable.

33.2.2 Contact materials

Low voltage and current contact material operating boundaries are summarised in figure 33.1. Two contact material approaches are adopted, alloys and metal contacts, and contacts with a surface finishing coating, usually plated or clad gold, *Au*.

Fine Silver, Ag

Fine silver has the best electrical and thermal properties of all metals. However, it is affected by sulphidation, which forms a film on its surface that increases contact interface resistance. Thus contact pressures must be sufficient to break through the film. While such pressures have no appreciable effect on silver-cadmium contacts, they do result in increased material wear of fine silver contacts. Also, an interface voltage of several hundred millivolts can occur with fine silver contacts because of the sulphide film. Controlled arcing burns off the sulphidation, and contact over-travel wipes away the residue. Breaking through this film generates electrical noise, so fine silver contacts are not used for low-level

switching, such as audio circuits. Therefore, fine silver and silver alloy contacts are for use in circuits of 12V, 0.4A, or more.

Gold-Flashed Silver, Au flash 3µm Ag

For relays that are inoperative for long periods before initial operation, sulphidation of silver contacts can result in an impregnable contact interface resistance. Instead of specifying silver contacts for such conditions, gold-flashed silver contacts are specified. Gold flashing on each contact results in minimal sulphidation/corrosion/oxidation during storage, and provides good electrical *make* upon contact. Because gold has a low boiling temperature, any flashing burns off after just a few switch cycles if arc voltage and current limits are exceeded. The silver under-layerment is then exposed, which may develop a sulphide film. Generally, gold-flashed contacts should not be subjected to arcing. Gold-flashed silver has the same qualities as 10µm plate Au, but is less durable.

Gold Overlay, plated 10µm Au – surface finish – clad, plating, flash thin film plating

A common contact for use in dry and low-load level switching circuits (>1mA/100mV) is gold overlay. The overlay is of sufficient thickness so as to not wear through to the base metal unless subjected to arcing conditions. This plating is removed by friction and erosion after around 1 million switching cycles in *dry circuits* (no current is switched).

Silver Nickel, AgNi 0.15 [+ 0.2µm to 5µm Au layer]

Depending on the application, material transfer may be prevalent with fine silver contacts. Typically, material tends to accumulate in the centre of one contact, while the loss of material on the other contact leaves a hole, or *pit*, leading to premature contact failure. In such applications, it is desirable to use fine grain silver contacts, in which alloying with 0.15% nickel gives the contacts a fine grain structure. As a result, material transfer is evenly distributed across the entire contact surface, resulting in longer contact life. Minimum contact load is 20V/50mA for a single contact, similar to Hard Silver Ag [97-98%], Cu+Ni.

Silver Nickel, AgNi 80:20

Used for switching loads greater than 10mA. Good resistance to contact wear and contact welding. Although slightly high contact resistance, it is used for dc switching with high inrush currents, as in automotive applications.

Silver Cadmium Oxide, AgCdO

Silver cadmium oxide contacts are used for switching loads that produce a high-energy arc. Such contacts are less electrically conductive than fine silver contacts, but have superior resistance to material transfer and material loss due to arcing. They exhibit greater interface resistance between mated contacts, and a slightly greater contact assembly temperature rise. It is used for high ac loads because it is more resistant to welding at high switching current peaks. Material evaporates/wears evenly across the surface. It is not recommended for strong dc breaking arcs because of the resultant wear (one-side reductions). The minimum arc voltage rating of silver cadmium oxide is 10V, minimum contact load is 20V/50mA, and, like fine silver contacts, the silver in this alloy will oxidize and sulphidate. Therefore, an arc is necessary to keep the contacts clean. This contact material, although RoHS Directive compliant, is being replaced by Silver Tin Oxide (AgSnO₂) and AgMeO.

Silver Tin Oxide, AgSnO₂

High melting point and high thermal stability. Tin oxide makes silver more resistant to welding at high making current peaks. It has a high burn out resistance when switching high loads and a low degree of material migration under dc loads. This is because any arc spreads to the outside of the contact preventing the creation of a local hot spot and potential weld. Minimum contact load is 20V/50mA. Such properties are useful where high inrush currents occur, such as lamp loads including fluorescent lighting. Silver Tin Oxide is frequently chosen as the replacement relay contact material for Silver Cadmium Oxide. Can be plated with 0.2µm of Au.

Silver Tin Indium Oxide, AgSnO₂In₂O₃

Silver tin indium oxide contacts, although not readily available, exhibit better resistance to arc erosion and welding than silver cadmium oxide contacts. They are less electrically conductive and are harder than silver cadmium oxide contacts. They have greater interface resistance between mating contacts and, therefore, a greater voltage drop and temperature rise. Silver tin indium oxide is more expensive than silver cadmium oxide, and the relay is limited to use in applications such as incandescent lamp loads and capacitors where there is an inrush current during contact bounce. For low and medium power resistive and inductive loads, silver cadmium oxide is most commonly used. Properties are similar to Silver Tin Oxide but it is more resistant to inrush. Minimum contact load is 12V/100mA.

Silver Copper Nickel, Ag (97-98%), Cu+Ni

The copper and nickel contents give the hardness. Single contact minimum load is 20V/50mA. Silver copper nickel contacts are for use in high inrush dc applications such as incandescent lamps and

capacitive loads. These contacts exhibit good resistance to welding, with a long contact life, but tend to oxidise at higher temperatures.

Palladium, Pd + (Cu/Ni/Ag, Rh coated), usually PdCu

Palladium contacts offer greater hardness, low contact wear and stable contact resistance thus do not sulphidate or oxidize, and so offer extremely low electrical noise levels. They have an electrical life expectancy of approximately 10 times that of fine silver contacts. However, because of relatively poor conductivity properties, load currents are limited to about 5A. Palladium contacts require 0.15mm to 0.30mm over-travel to insure good wiping action. Because of this, they are used primarily on telephone-type relays, that is, relays on which the contact arms are parallel to the length of the coil, and on which such over-travel is easy to obtain. Also, palladium contacts should be bifurcated (multiple contacts operating in parallel) to help ensure circuit continuity on contact closure.

Tungsten, W

More resistant to welding at high loads than hard silver, with a high burnout resistance, tungsten is a good standard contact material, used on some heavier duty relays. Minimum contact load is 20V/50mA for a single contact. Tungsten contacts are for use in high voltage applications, usually where highly repetitive switching is required. Tungsten has a melting temperature of 3,380°C, which gives it excellent arc-erosion resistance. Tungsten may develop unwanted oxide films, especially when used as the anode contact in some dc applications. Therefore, tungsten is often used as the cathode contact, and a palladium alloy is used as the anode contact. Such a combination also minimizes contact interface resistance and material transfer.

Table 33.1: Contact materials for low voltage relays

Contact material	Typical features	V, I, P values
AuAg8 (Gold F)	For low-resistance applications at low load Low constant contact resistances For measuring currents, dry switching	µV - 24V µA - 0.2A < 5W
Rh	For high-resistive applications at low load Galvano-technical contact coating in µm range for reed contacts with higher endurance	< 150V < 2A
PdNi (Ni content 20 to 50%)	Galvano-technical contact coating with similar features to Rh Powder metallurgical contacts are also possible Laminar creep of material	< 150V < 5A
Ag-pure and Ag fine grain (Ni content 0.15%)	Most common contact material; universally applicable Sulphur sensitive, therefore often flash-golded Also suitable for alternating current	1V - 150V 50mA - 100A > 1W
AgPd (Pd content 30 to 50%)	Important material in communications technology Good burn-up resistance Sulphur insensitive Slightly higher contact resistances than with Ag	1V - 150V 50mA - 5A
AgNi (Ni content 10 to 20%)	Important material for inductive loads Suitable for make currents up to 50A Good burn-up resistance Low susceptibility to welding Higher contact resistances than with Ag	6V - 380V 10mA - 100A
PdCu15	For lamp loads in the automotive field (pulsed operation) Burn-up resistant, long endurance Laminar creep of material Higher specific insulation resistances that are not constant	6V - 24V 5A - 20A
AgCd0 (Cd content 8 to 15%)	Material for alternating current Burn-up resistant Low susceptibility to welding	12V - 380V > 0.5A > 10 W
AgSnO ₂ (Sn content 8 to 15%)	Material for direct and alternating current Burn-up resistant Low susceptibility to welding Environmentally friendly (replacement for AgCd0)	> 12V - 380V > 0.5A > 10W
W <i>Platinum</i>	For high make currents (as pre-travel contact) For higher switching rates Burn-up resistant, low susceptibility to welding Subject to corrosion	> 60V > 1A > 50W

Gold Silver Nickel Alloy

Gold silver nickel alloy contacts are used for switching loads generally of less than 1A, and are characterized by less electrical noise on make and break than fine silver contacts. Gold diffused silver contacts offer characteristics similar to gold silver nickel alloy, but are less expensive. Other gold-based alloy contact materials include AuPd (Pd <5%) and AuCo for galvanic deposited gold layers.

Platinum Iridium, PtIr

Platinum has a high corrosion resistance, being much less prone to erosion in comparison with silver. In pure form, it is low in hardness and therefore is generally alloyed with other materials. Platinum-iridium combines hardness with excellent resistance to the formation of arcs.

Mercury, Hg

Mercury has a melting temperature of -38.9°C . Thus, as used in relays, it is in a liquid state. Mercury clings to the surface of any clean metal, and is used as the contacts in mercury-wetted reed relays. It has good electrical conductivity and, being liquid, there is no material transfer build-up from contact to contact. Any such material transfer is negated by the fact that when the contacts open and the mercury returns to the pool in the bottom of the relay, fresh mercury takes its place at the next switch operation. Mercury has a boiling temperature of 357°C . Because of this, mercury contacts cannot switch currents of more than a few amperes.

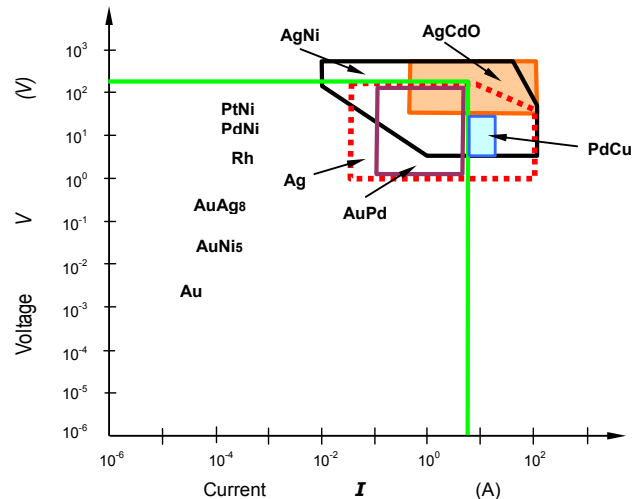

Figure 33.1. Low voltage and current contact materials.

33.2.3 Contact Life – material loss and transfer

The electrical life expectancy of general purpose and power relays is normally rated to be 100,000 operations minimum, while mechanical life expectancy may be in excess of one million operations. The reason electrical life is rated so low compared with mechanical life is because contact life is application dependent. The electrical rating applies to contacts switching their rated loads. Rated electrical life also takes into consideration arc destruction of the contacts. By the use of appropriate arc suppression, contact life may be lengthened.

Contact life is terminated when the contacts stick or weld, or when excessive material is lost from one or both contacts and a good electrical *make* is not possible. These conditions are the result of cumulative material transfer during successive switching operations, and of material loss due to splattering. Material transfer occurs due to Joule I^2R heat. Material loss is due primarily to splattering of the molten and boiling metal as contacts bounce on *make*.

In dc applications, metal migration is predictable in that one contact is always negative, and the other, positive. In ac applications where switching is random, either contact may be negative or positive when arcing occurs. Migration will not be in the same direction each time the contact *breaks*, and material loss from either contact should not be significant, unless load conditions cause splattering.

Controlled arcing of short duration can be beneficial in achieving the rated life of the contacts, because such arcing burns off any deposits on the contacts that might prevent electrical *make*. Such control is achieved by arc suppression. Unless arcing and/or contact over-travel cleans the contacts, films may develop on the contact surfaces, or foreign matter may collect. For this reason, it is best to apply general purpose and power relays only in applications where the load voltage (or counter emf) and current are in excess of the arc voltage and current ratings of the contacts.

Table 33.2 lists some arc voltage and current values for several different metals. An arc will ignite if both the minimum arc voltage and current are exceeded. However, there will be no arc if load current at a given minimum arc voltage is less than the minimum arc current for that voltage. Likewise, there will be no arc if load voltage (or counter emf) is less than the minimum arc voltage of the contact metal.

At voltages and currents of less than those required to ignite an arc, a spark may occur between separating contacts. This spark is a capacitive discharge, and is weak compared to an arc. Even so, the spark may be sufficient to keep sulphidation, oxidation, and contaminates from building up on the contacts. An arc suppression network has virtually no effect on contact sparking.

Table 33.2: Contact material characteristics

Material	Electrical Conductivity %IACS	Melt Voltage	Arc Voltage	Arc Current
Cadmium	24		10	0.5
Copper	100	0.43	13	0.43
Gold	77	0.43	15	0.38
Nickel	25	0.65	14	0.5
Palladium	16	0.57	15	0.5
Silver, fine	105	0.37	12	0.4
Tungsten	31	0.75	15	1.0

A method of quenching an arc between separating contacts is with an RC network placed directly across the contacts. As the contacts just begin to separate and an arc ignites, load current feeding the arc is shunted into the capacitor through the series resistance, depriving the arc of some of its energy. As a result, arc duration will be shortened and material loss will be reduced.

The term *fritting* describes the electrical breakdown of the oxide (or other foreign material) layer when a sufficiently high voltage is applied across a closed contact. Due to the applied voltage and short distance between the low potentials, a high electric field is generated. This electric field destroys the thin non-conductive layer and establishes a metal bridge electrically linking the two surfaces. The *fritting* voltage level depends on the contact material, composition and thickness of the layers, and the composition of the contact surfaces.

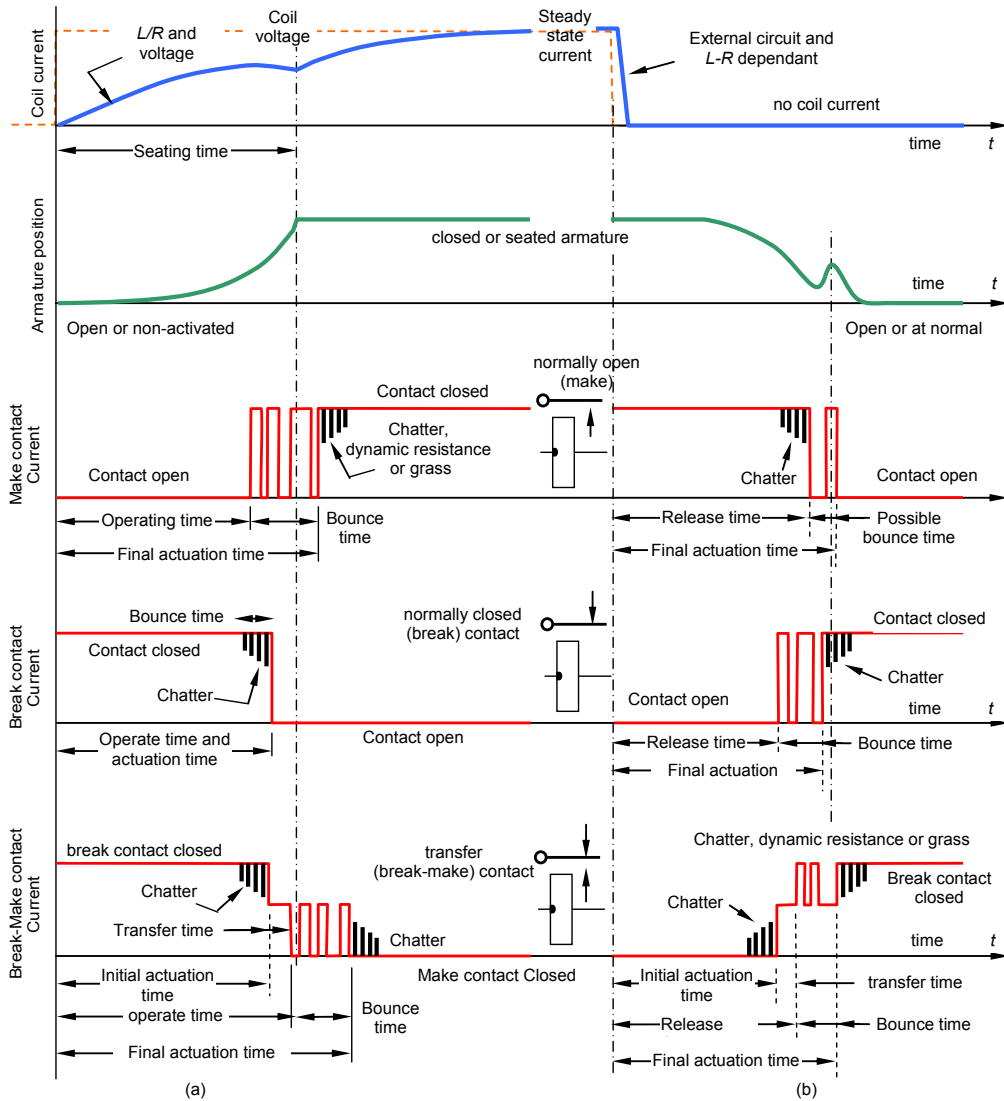

Figure 33.2. Voltage and current waveforms typical of relay (a) pick-up and (b) drop-out. Contact currents for non-inductive load.

33.3 Defining relay performance

There is a sequence of events in relay pick-up (operate) and drop-out (release) with respect to current rise and decay. The events are defined in terms of duration of coil current, armature motion, and contact actuation. Figures 33.2 (a) and (b) show contact performance as a series of time domain waveforms, for a relay with a normally open contact, a normally closed contact, and a transfer (break-make) contact. Figure 33.3 shows the relationship between parameters defining relay performance and their definitions, which follow.

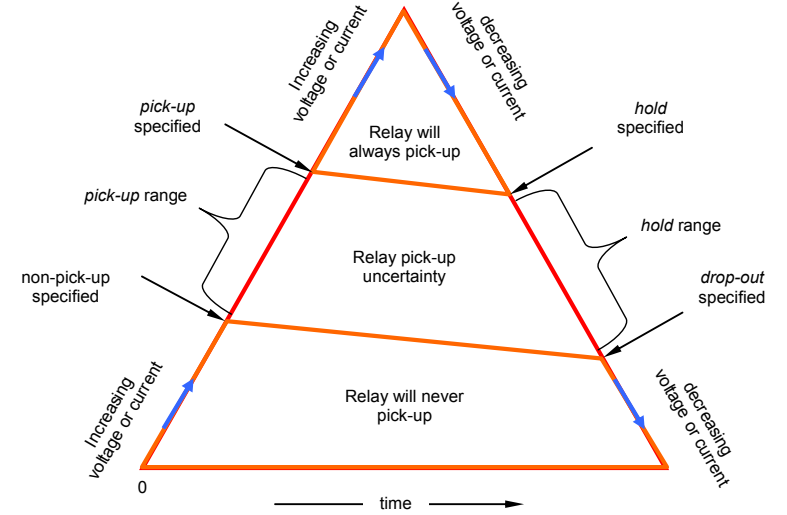

Figure 33.3. Graphical presentation of relay performance related definitions.

Pick-Up (figure 33.2a): Upon coil energization, current begins to rise exponentially at a decreasing rate, but no armature movement occurs until the power develops sufficiently to operate the contact spring load. This period is sometimes referred to as *waiting time*. Contact actuation occurs during the armature movement. The *final actuation time* exceeds the *initial actuation time* by the amount of the contact bounce. For normally closed contacts, operate time and initial operate time are identical. On break-make contacts, the time interval between initial opening of the normally closed contact and closure of the normally open contact is called *transfer time*.

Drop-out (figure 33.2b): On de-energization of the coil, the magnetic flux does not cease immediately. The length of time it persists depends upon the release characteristics of the coil (fast-to-release, slow-to-release, and the like). The sequence of events described under pickup is essentially reversed under dropout. A normally open contact may be momentarily re-closed as a result of armature rebound off the backstop. This effect, which is not always present, depends on many factors, such as contact spacing, contact spring load, backstop design, etc.

Closing Arc

As a contact is activated, and two points come together to carry current, an arc is formed. This causes material to evaporate, and if high transient currents are present (say starting a motor or a fluorescent lamp) then large portions of the contact surface may melt causing the contacts to weld. The process is reinforced by contact bounce. As the contacts close, the arc is suppressed; it appears as a peak.

Opening Arc

To break a circuit, a contact will open. As it does, the effective contact surface is reduced due to the decreasing contact force and movement. The current flow is the same, and therefore the current density in the remaining pathway increases up to the melting point. An explosion like process can occur as the contact material springs out. An arc may be produced by:

- resistive and capacitive loads in conjunction with high voltages
- inductive loads

Permanent or sustained arcs are produced mainly by dc currents. Alternating current quenches the arc when the current crosses the zero current level. Arcs are influenced by contact material, a reduction in arcing voltage and arcing current and the speed of the breaking elements. When switching high dc loads, a larger contact gap and blow out magnet may be critical.

Relay switching performance is affected by high ambient temperatures (as shown in figure 33.4), humidity, dust, and contaminant gases. A relay itself creates heat and oxidants as it operates. The other influencing factors on relays electrical service life is the arc produced when the contacts open and close. Contact friction, clearance mechanical quality, etc. are of lesser significance.

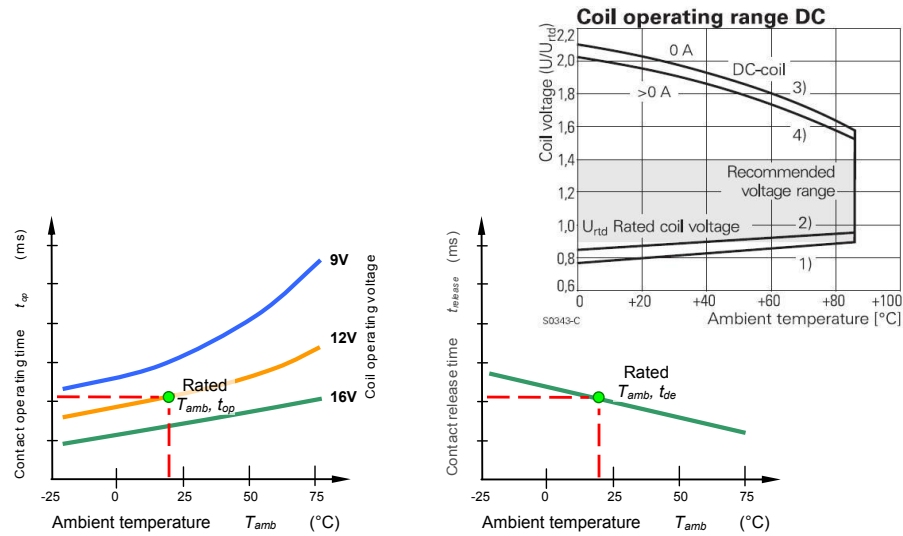

Figure 33.4. Contact operate and release time dependence on coil temperature.

33.4 AC and DC relay coils

i. AC across a DC coil relay

In theory, ac can be used to operate a dc relay but this is not so in practice. Since alternating current decreases to zero every half-cycle (100 times per second for 50Hz voltage or 120 times per second for 60Hz voltage), the relay armature tends to release every half-cycle. This continual movement tendency of the armature not only causes an audible buzz, but will cause the contacts to open and close as the armature moves.

In order to operate a relay from ac, a device known as a shader ring (or shader coil) is used on top of the core. Because of the shader ring, the magnetism developed in part of the core lags the magnetism of the remainder of the core. That is, there is a slight phase displacement between the magnetism of parts of the core. Thus, as unshaded-core magnetic energy decreases to zero every half-cycle, the magnetic energy decreases to zero every half-cycle, the magnetic energy still present in the shaded portion of the core holds the armature sealed. By the time the energy in the shaded portion decreases to zero, coil and unshaded core magnetic energy have begun to increase once again as current increases.

ii. DC across an AC coil relay

An ac relay may be operated from dc provided two precautions are taken.

i. The first precaution is to provide some type of a residual break between relay core and armature to prevent the armature from sticking as a result of any appreciable residual magnetism remaining in the core after coil power is removed. AC relays are so constructed that when the armature is in its seated position, it physically (magnetically) touches the core. (On dc relays, a small copper pin in the armature effectively prevents the armature from coming in magnetic contact with the core.) As long as the ac relay is operated from AC voltage, there is no problem with residual magnetism holding the armature seated after release of coil power. But when an ac relay is operated from dc voltage, there is a danger that residual magnetism may hold the armature seated. At the very least, the presence of residual magnetism in the core causes a reduction in the dropout voltage of the relay. To negate the effects of residual magnetism, a small piece of mylar tape may be stuck to the top of the ac relay core. This tape is extremely durable, and should last for perhaps hundreds (if not thousands) of operations. The tape is 0.05mm to 0.1mm thickness.

ii. The second precaution to be taken is to ensure the dc voltage used is less than the ac voltage rating of the coil. To use an ac coil on dc requires lowering the amount of dc voltage to that value where coil power is within maximum limits. When using rectified ac to operate any relay coil, it is best to use capacitive filtering to reduce the voltage ripple to less than 25%

33.5 Temperature consideration of the coils in dc relays

Relays and temperature are intertwined, where a rise in temperature causes a rise in electrical resistance. When a relay is exposed to various temperatures, its operating characteristics, specifically here, pull-in and dropout, change dependent upon the temperature. The most notable changes occur in the pick-up voltage V_{PI} and coil resistance R_C , as implied by the parts of figure 33.4. The coil winding of a relay is produced with copper wire and thus the coil resistance varies with the temperature coefficient of copper. For the temperature range that a relay will normally be exposed to, the resistance change in copper is of the form:

$$R_1 = R_0 \times (1 + \alpha \times \Delta T) \quad (33.1)$$

where: R_1 = Resistance at temperature T_1 , Ω

R_0 = Resistance at temperature T_0 , Ω

$\Delta T = T_1 - T_0$, change in temperature from T_0 , $^{\circ}\text{C}$

α = Slope of a line from a point (-234.5, 0) through the point ($T_0, 1$)

$\alpha = 0.003929$ at $T_0 = 20^{\circ}\text{C}$ or 0.003853 at $T_0 = 25^{\circ}\text{C}$, $^{\circ}\text{C}^{-1}$

T_1 = New operating temperature, $^{\circ}\text{C}$

T_0 = Reference temperature, where 20°C or 25°C are typically used references, $^{\circ}\text{C}$

For a dc relay, the magnetic force developed is proportional to the Ampere-turns developed in the coil. Since the mechanical forces are nearly constant over the normal temperature range (and the number of turns is fixed), the pick-up current, I_{PI} , will be constant. If pick-up current is constant and coil resistance varies, the pick-up voltage, $V_{PI} = I_{PI} \times R_C$, varies directly as the coil resistance. This leads to a simple mathematical method to determine coil resistance and pick-up voltage V_{PI} at any temperature if a reference point V_{PI0} is known.

$$V_{PI1} = V_{PI0} \times (1 + \alpha \times \Delta T) \quad (33.2)$$

While temperature changes affect relay parameters, the power dissipated within the relay also affects the temperature in most applications. The power dissipated within the relay comprises a number of components. Heat generated in the relay coil when voltage is applied to it. This heat creates a temperature rise in the relay coil and package. The temperature rise is dependent upon several factors such as the volume of copper wire used, insulation thickness, insulation type, bobbin material, bobbin thickness, terminal size, conductor size, and several other factors that are design related. Each of these factors will either enhance or resist the flow of generated heat from the coil assembly and into the ambient air. For a given relay design, these factors can be accumulated into the 'coil to ambient thermal resistance' of the relay, in $^{\circ}\text{C}/\text{W}$. The thermal resistance is analogous to the electrical resistance and the temperature rise created by coil power dissipation follows the equation:

$$\Delta T_{RC} = R_{\theta CA} \times P_d = R_{\theta CA} \times \frac{V_A^2}{R_C} \quad (33.3)$$

where: ΔT_{RC} = Temperature rise caused by coil power dissipation, $^{\circ}\text{C}$

$R_{\theta CA}$ = Thermal resistance from coil to ambient, $^{\circ}\text{C}/\text{W}$

P_d = Steady-state power dissipated in the coil, due to coil resistance R_C and coil voltage V_A , W

For normal relay temperature ranges, this relationship is nearly linear and consistent under the following conditions:

- The relay is in still air and not subjected to significant airflow or the value of θ_{CA} was determined with an airflow identical to the end application.
- All power calculations deal with the coil resistance at the final coil temperature T_C attained. If only room temperature coil resistance were used, the resulting non-linearity would result in significant errors at higher temperatures.

The value for thermal resistance is specified when the relay carries no load current. The final coil temperature can be calculated using manufacturer's parameter data under no load relay conditions.

Under contact load conditions, the contact power dissipation may be treated as a separate heat source that adds heat into the relay package. Its effect on coil temperature is dependent upon many factors including package size, contact to coil distance, contact terminal size, connecting wire size, shared thermal paths, etc. These factors can be lumped into a contact to coil thermal resistance, which leads to

$$\Delta T_{RL} = R_{\theta CC} \times P_K = R_{\theta CC} \times I_L^2 R_K \quad (33.4)$$

where: ΔT_{RL} = Temperature rise caused by load dissipation in the contacts, $^{\circ}\text{C}$

$R_{\theta CC}$ = Thermal resistance from the contacts to the coil, $^{\circ}\text{C}/\text{W}$

P_K = Power dissipated in the contacts, W

R_K = Resistance of contact circuit, assumed temperature independent, Ω

I_L = Load current flowing through the created by the contacts, A

Based on practical data, the contact temperature rise can be approximated by

$$\Delta T_{RL} = k_R I_L^{1.85} \quad (33.5)$$

The final coil temperature rise above ambient, is the sum of the two heat source components, self-heating and that due to contact heating, namely

$$\begin{aligned} T_C &= T_A + T_{RC} + T_{RL} \\ &= T_A + R_{\theta CA} \times \frac{V_A^2}{R_C} + k_R I_L^{1.85} \end{aligned} \quad (33.6)$$

Example 33.1: Relay coil thermal properties

For a dc relay under the following no-load conditions:

$$\begin{aligned} T_o &= 20^\circ\text{C}, & V_o &= V_{PI} = 6.8\text{V}, & R_o &= 90\Omega, & V_A &= 13.5\text{V} \text{ (the applied coil voltage)} \\ R_{\theta CA} &= 40^\circ\text{C/W}, & T_A &= 85^\circ\text{C}, & I_L &= 0\text{A} \text{ (no load current)} \end{aligned}$$

determine:

- Cold-start pick-up voltage (with the coil previously un-energized) and coil resistance at T_A
- Final steady-state coil temperature T_C and resistance for an applied coil voltage V_A
- Hot-start pick-up voltage (after coil energized at V_A) at T_A and V_A ; and
- For a 20A contact load, with $k_R = 0.29$ modelling the relay contacts, determine the new steady-state thermal operating conditions.

Solution

The pick-up current is virtually independent of thermal conditions since it is based on magnetic circuit Ampere-turns. Therefore the expected coil current is $V_{PI} / R_o = 6.8\text{V}/90\Omega = 75.56\text{mA}$, at all operating temperatures.

- i. The resistance at an operating temperature of 85°C is given by

$$\begin{aligned} R_i &= R_o \times (1 + \alpha \times (T_i - T_o)) \\ &= 90\Omega \times (1 + 0.003929 \times (85^\circ\text{C} - 20^\circ\text{C})) \\ &= 90\Omega \times 1.2554 = 113\Omega \end{aligned}$$

The voltage at this temperature is obtained using the same scaling factor since the necessary current is assumed independent of temperature.

$$\begin{aligned} V_i &= V_o \times 1.2554 \\ &= 8.54\text{V} \end{aligned}$$

- ii. Since $T_C = T_A + T_{RC}$ and $P_d = V_A^2 / R_C$ then

$$\begin{aligned} T_C &= T_A + R_{\theta CA} \times \frac{V_A^2}{R_C} \\ &= 85^\circ\text{C} + 40^\circ\text{C/W} \times \frac{13.5\text{V}^2}{R_C} \end{aligned}$$

Since R_C is temperature dependant, an iterative solution is necessary to determine T_C and R_C . After several iterations $T_C = 140^\circ\text{C}$, which leads to a coil resistance at this temperature of

$$\begin{aligned} R_C &= R_o \times (1 + \alpha \times (T_i - T_o)) \\ &= 90\Omega \times (1 + 0.003929 \times (140^\circ\text{C} - 20^\circ\text{C})) \\ &= 90\Omega \times 1.4715 = 132.4\Omega \end{aligned}$$

- iii. The hot-start relay pick up voltage is therefore

$$V_i = 6.8\text{V} \times 1.4714 = 10.0\text{V}$$

Thus the necessary ampere-turns relay coil current is $10.0\text{V}/132.4\Omega = 75.6\text{mA}$, independent of temperature.

- iv. For a 20A load current through the contacts:

$$\begin{aligned} T_C &= T_A + R_{\theta CA} \times \frac{V_A^2}{R_C} + k_R I_L^{1.85} \\ &= 85^\circ\text{C} + 40^\circ\text{C/W} \times \frac{13.5\text{V}^2}{R_C} + 0.029 \times 20^{1.85} \end{aligned}$$

Again, since R_C is temperature dependant, an iterative solution is necessary to determine T_C and R_C . After several iterations $T_C = 146.5^\circ\text{C}$, which leads to a coil resistance at 146.5°C of

$$\begin{aligned} R_C &= R_o \times (1 + \alpha \times (T_i - T_o)) \\ &= 90\Omega \times (1 + 0.003929 \times (146.5^\circ\text{C} - 20^\circ\text{C})) \\ &= 90\Omega \times 1.4970 = 134.73\Omega \end{aligned}$$

The hot-start relay pick up voltage is therefore

$$V_i = 6.8\text{V} \times 1.4970 = 10.18\text{V}$$

Thus the necessary ampere-turns relay coil current is $10.18\text{V}/134.73\Omega = 75.6\text{mA}$, independent of temperature.

The values obtained in example 33.1 apply to dc relay coils operated continuously at these values. Intermittent duty (with short, that is, less than one minute, on-times and longer off-times) may result in substantially lower temperatures. Therefore, if a specific duty cycle is given for the relay operation, testing at these conditions could yield acceptable results for final coil temperature when the continuous duty temperatures calculated in example 33.1 would not. The methods discussed are applicable to standard dc relays and while the coil resistance formula is applicable to polarized dc relays (one that utilizes a permanent magnet) and ac relays as well, the pick-up voltage equations will not work in such cases. With a polarized dc relay the temperature induced change in magnetic force of the magnet must be considered. This is normally such that it reverses part of the change in pick-up voltage caused by the copper wire resistance. In the case of ac relays, the inductance contributes a significant portion of the coil impedance and is related to the turns in the coil. Since the inductance varies only slightly with temperature, the pick-up voltage exhibits less variation over temperature than for dc coil relays.

33.6 Relay voltage transient suppression

Voltage suppression is applicable to relay coils and relay contacts. The circuitry used is similar for each suppression case.

Although coil voltage suppression is used extensively, relays are normally designed and specified without taking into account the dynamic impact of suppressors. The optimum switching life (for normally-open contacts) is therefore obtained with a totally unsuppressed relay and rated electrical life factors are then based on this premise. Improper relay coil suppression has the typical symptom of random *tack welding* of the normally-open contacts when switching an inductive load or high inrush currents like with a lamp load. The successful *breaking* of a dc load requires that the relay contacts move to open with a reasonably high speed.

When an electromechanical relay is de-energized rapidly by a mechanical switch or semiconductor, the collapsing magnetic field produces a substantial voltage transient ($V = Nd\phi/dt = Ldi/dt$) in an effort to release the coil stored energy ($W = \frac{1}{2}LI^2$) and oppose the sudden change of current flow. A 12V/28V dc relay coil, for example, may generate a voltage of over 1kV during unsuppressed turn-off. This relatively large voltage transient can create EMI, semiconductor breakdown, and switch wear problems. It is thus common practice to suppress relay coil voltages with other components which limit the peak voltage to a controlled defined level. The measure of successful coil suppression depends on the degree to which the method affects the operation of the relay contacts. Improper or excessive suppression can cause the relay to suffer from a long release time, slow contact transfer, and contact bounce on break. All of these conditions will increase contact arcing when load switching, which reduces relay life.

33.6.1 Types of transient suppression utilized with dc relay coils

Coil de-activation

A typical relay will have an accelerating motion of its armature toward the un-energized rest position during drop-out. The velocity of the armature at the instant of contact opening will play a significant role in the relay's ability to avoid *tack welding* by providing adequate force to break any light welds made during the *make* of a high current resistive load (or one with a high in-rush current). It is the velocity of the armature that is most affected by coil suppression. If the suppressor provides a conducting path, thus allowing the stored energy in the relay's magnetic circuit to decay slowly, the armature motion is retarded and the armature may even temporarily reverse direction. Any direction reversal and re-closing of the contacts (particularly when combined with inductive loads) can lead to random, intermittent *tack welding* of the contacts such that the relay may free itself if operated again or even jarred slightly.

The basic techniques for suppression of transient voltages across relay coils are based on the suppression device in parallel with the relay coil or in parallel with the switch used to control the relay. It is normal to have the suppression parallel to the coil since it can be located closer to the source of the

problem, the relay coil (except in the case of PC board applications where either may be used). Better switch transient voltage protection is afforded when the suppression circuit is across the controlling switch, as shown in figure 33.5. Suppression used in parallel with the switching element is likely to be either a Zener diode or a series resistor-capacitor snubber. The Zener diode control method is most advantageous since it does not significantly reduce relay endurance. See Chapter 7 section 7.2.1.

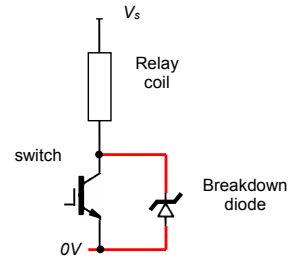

Figure 33.5. Indirect coil voltage suppression.

When the suppression is in parallel with the relay coil, any of the topologies in figure 33.6 may be used.

- i. A reversed-biased rectifier diode.
- ii. A bilateral transient suppressor diode that is similar in V - I characteristics to two Zener diodes series connected cathode to cathode (or anode to anode).
- iii. A metal-oxide-varistor (MOV).
- iv. A reverse-biased rectifier diode in series with a Zener diode such that their anodes (or cathodes) are common and the rectifier prevents coil-activated current flow. The Zener voltage is two or three times the level of the nominal voltage of the relay.
- v. A reversed-biased rectifier diode in series with a resistor.
- vi. A resistor, when loss conditions permit its use, is often the most economical suppression.
- vii. A series resistor-capacitor snubber. Generally the least economical solution, figure 33.6e.
- viii. A bifilar wound coil with the second winding and series diode used as the suppression circuit. This is not practical since it adds significant cost, losses, and size to the relay.

i. Diode clamped coil

A diode as in figure 33.6a clamps the cut-off spike to approximately 0.7V. However, the energy maintained by the continued current flow increases the release time. Some relays can reverse their armature movement direction when returning to the rest position due to a current flow increase. This can cause the make contact to close again under certain circumstances and can lead to an increased arc duration. This results in reduced endurance, hence the clamped diode configuration is not recommended for higher load currents.

The use of a rectifier diode alone to provide the transient suppression for relay coils may be cost effective and eliminates any transient voltage, but its impact on relay performance can be devastating, since the flux producing Ampere-turns decreases slowly, increasing the de-energized time. Problems of unexplained, random *tack welding* can occur. In some applications, this problem is only a minor nuisance or inconvenience and the relay can be cycled until the proper response is obtained. In some applications, the first occurrence of welding may cause a complete system failure or even present a hazardous situation.

Energize time of a relay can be increased and high voltage transients eliminated with an inductor/diode combination placed between the power supply and the relay, as in figure 33.6b - which is problematic. The series inductor does decrease interwinding capacitor current magnitudes.

ii. and iii. Silicon transient suppressor diode or MOV

Based on armature motion impact and optimizing for normally open contacts, the best suppression method is to use a silicon transient suppressor diode, as shown in figure 33.6c. This suppressor will have the least effect on relay dropout dynamics since the relay transient will reach and be maintained at a predetermined voltage level and permits coil current to flow into low dynamic impedance. This results in the stored energy being quickly dissipated by the suppressor. Bi-directional transient suppressor diodes permit the relay to be non-polarized when fitted internally. If a uni-directional transient suppressor is used, it must be used with a series rectifier diode to block normal current flow and it has little advantage over the use of a Zener diode, as in figure 33.6d. The transient suppressor should be selected such that its pulse energy rating exceeds any anticipated transient, such as coil turn-off or motor 'noise'. MOVs produce virtual identical waveforms as silicon suppression diodes, but MOV clamping properties can deteriorate with continuous electrical stressing.

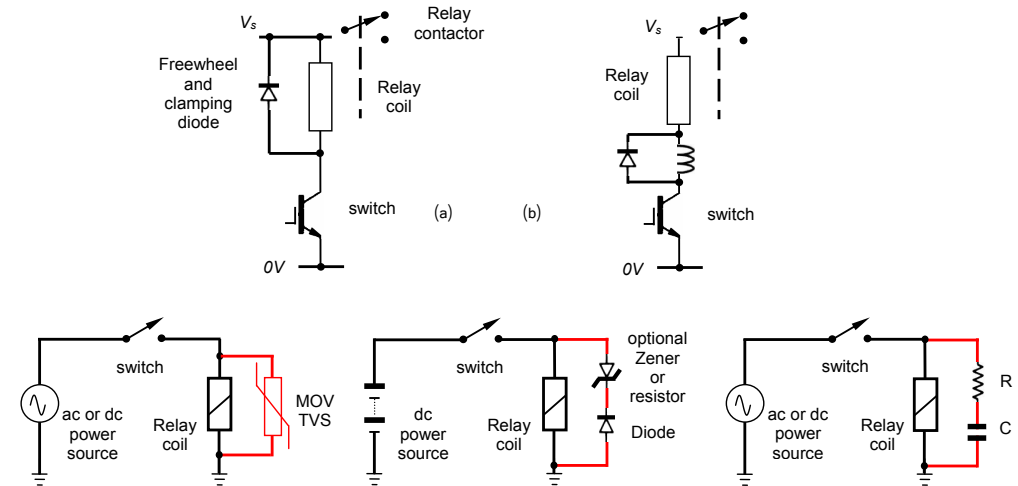

Figure 33.6. Various relay coil voltage suppression techniques.

iv. Zener + diode

If back EMF suppression of the relay coil is needed, use a Zener-Zener or diode-Zener series (figure 33.6d) combination with a Zener voltage at least twice the coil source voltage. The use of a reversed-biased rectifier diode in series with a Zener diode will provide the best solution when the relay can be polarized, since the Ampere-turns is reduced rapidly.

In relay carry-only applications, the release time may not be important and less expensive coil suppression techniques can be used. However, if the release/reset time is important, or if the contacts are to interrupt a load, then the Zener-Zener or diode-Zener combination may not be applicable.

v. Parallel resistance

The parallel resistance should be so rated that its value corresponds to approximately six times the coil resistance. In this way, the external cut-off spike is limited to three times the operating voltage. At a nominal voltage of 12V, the external spike can be contained to less than 36V. At a cost increase, coil activation losses can be reduced by adding a series diode, as indicated in figure 33.6d.

Table 33.3: The effects dc coil suppression on relay drop-out time

Suppression technique	Drop-out Time	Theoretical Transient
	ms	V
Unsuppressed	1.5	undefined
Diode + 24V Zener	1.9	-24.8
680Ω resistor	2.3	-167
82Ω resistor	6.1	-20.1
Diode	9.8	-0.8

These suppression techniques are based on normally-open contact performance, and must be qualified for normally-closed contacts. When the primary load is on, the normally-closed contacts (and a small load or none on normally-open), it may be desirable to use a rectifier diode alone as relay suppression (or perhaps a rectifier diode and a lower value of series resistor). The retarded armature motion that adversely impacts normally-open contact performance will typically improve normally-closed contact performance. Improved performance results from less contact bounce during closure of the normally-closed contacts. This results from the lower impact velocity created by the retarded armature motion and can be utilized to improve normally-closed contact performance on certain relays. Table 33.3 show how increased coil reset voltage decreases relay drop-out time.

Pulse Width Modulation (PWM) and relay coils

A method to regulate the power consumption of a source supplying a relay is with a dc current driver, since the main electrical parameters of a relay (pull-in, pull-through and holding currents) are to a certain extent temperature independent. Since relay coils are usually voltage driven, those characteristics translate into the temperature dependent voltages for pull-in, pull-through and holding, due to the temperature dependence resistance of the coil copper wire.

Once the relay has pulled in, it maintains this status (armature maintains the contact position on the core) unless the coil current falls below the holding current, as shown in figure 33.7. For shock and vibration tolerance, there is an overhead current required, which depends on the relay type, relay parameters, temperature variation, and shock and vibration requirements.

PWM controlled drivers regulate the effective applied voltage by changing the fixed frequency duty ratio of the dc voltage. Inductive systems like relay coils, in the presence of parallel connected fast recovery freewheel components, respond to a negative going voltage edge with an exponential current decay.

Relay coil inductances are relatively high, with low resistance, which results in comparatively long time L/R constant hence small current ripple. But the R and L values are not constant. The relay coil inductance depends on the coil current (saturation) and status of the relay (armature open or closed). The coil copper wire resistance is highly temperature dependant.

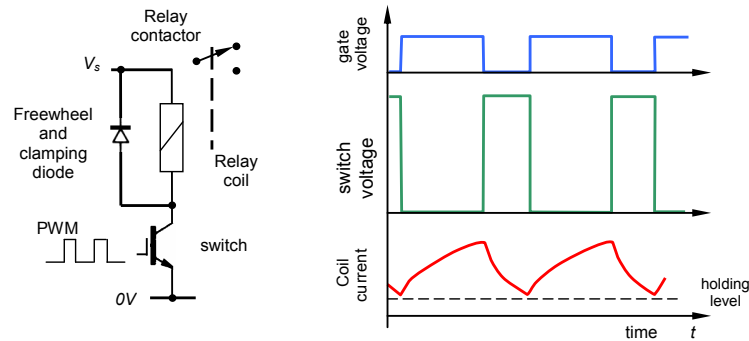

Figure 33.7. Coil current response to a PWM voltage, with a parallel freewheel diode.

Alternatively, using a series diode-Zener increases the ripple current, which must not fall below the minimum holding current level, as shown in figure 33.7.

Coil activation

The definition of operate time is the interval between the application of the nominal coil voltage and closing of all normally open contacts (or opening of all normally closed contacts). This includes:

- Time for the coil to build up the magnetic field due to the increasing current.
- Transfer time of the movable contact.
- Bounce time after the initial make or break.

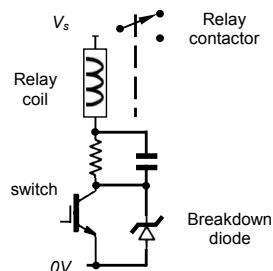

Figure 33.8. Reduction of relay activation time.

Operate time is essentially a function of the coil power (specifically current, Ampere-turns) and inductance (L/R time constant). Standard circuit techniques can be used to alter relay timing characteristics. More than half the switching time is taken to build up the coil field, thus the basic scheme for reducing operate-time is to apply more voltage across the coil. Faster relay operating speed can be accomplished by overdriving the coil with a higher than nominal voltage. For example, a 28V dc coil should not exceed 35V dc for continuous duty. To prevent overheating, the coil voltage should be reduced to the nominal value (or above the holding current level) shortly after the relay operates or a resistor equal to or greater in value than the coil resistance should be placed in series with the coil to keep the total power applied at a specified level. Doubling the nominal voltage and adding an external resistor equal to the coil resistance can reduce the operate time by 40%.

A fast operating speed can be achieved by using an over-voltage pulse that decays to normal operating potential in a few milliseconds, as shown in figure 33.8, which achieves this with a simple parallel RC network placed between the power supply and the relay coil. Interwinding capacitance is problematic.

33.6.2 Relay contact arc suppression, protection with dc power switching relays

Transient and arcing occurs during relay *make* (close), *break* (open) and contact bounce. Arcing can drastically lower the life expectancy of relays. Over 70% of relay failure occurs at the contacts. The most prevalent relay failure mechanisms are increased contact resistance, contact contamination, and material loss. Relay contact life expectancy is commonly a function of how much arcing can be withstood before failure occurs. Arc duration is often determined by the contact separation speed. Arcing, particularly during switching of inductive loads in high-voltage circuits, can be destructive. To achieve maximum contact life, reliable arc suppression is important. It is difficult to prevent all arcing, but employing an arc suppression circuit will extend contact life.

Vacuum and hydrogen gas filled relays and contactors are often used in direct current electrical systems. Switching a direct current load is onerous on a relay. The relay or contactor needs to clear the maximum fault current, which is usually several times higher than the normal load. Unlike ac power, where both voltage and current regularly pass through zero allowing the arc formed during switching to naturally extinguish, a dc load can only be interrupted by forcing the arc voltage higher than the effective source voltage. A number of mechanisms are used to increase the arc voltage, ranging from arc chutes or multiple contacts, to magnetic blow-out, which lengthens the arc path.

Power switching relays are designed to interrupt rated power. However, reactive inductive loads can result in significant voltage overshoot, which can be suppressed by a variety of measures, usually more robust than the method used for relay-coil voltage suppression.

Figure 33.9 shows methods used to reduce the load on contacts by limiting the peak voltage transient developed across the relay contacts when interrupting inductive loads. The same circuits across the load will protect the load and contacts from voltage overshoot.

- Figure 33.9a shows a metal oxide varistor (MOV) across the power contacts. This circuit is suitable for most general-purpose ac and dc applications and MOV selection depends on transient energy, etc. MOVs are compact in size and low in cost. They protect contacts from high breaking voltages with minimal additional drop out delay. They have limited switching frequency and are optimised for a specific voltage. Suppression diodes perform similarly. See chapter 12.3.
- Figure 33.9b shows an MOV in series with an SVP (Surge Voltage Protector - spark gap). The MOV absorbs transient overshoot energy, the SVP provides excellent dielectric isolation once the circuit is open. This solution is also compact in size and low cost. See chapter 12.3.2i.
- Figure 33.9c illustrates the use of a traditional RC snubber, which will suffice for low power and energy ac and dc situations, but suffers a size and cost penalty at high power. RC elements are bidirectional, with minimal drop-out delay. A low overvoltage can be achieved, but is not suitable for low voltages. A disadvantage is a capacitor can lead to high making currents.

The main drawback of any relay contact protection circuit that restricts the arc voltage, is increased release time. Protection (rectifier) diodes have a breaking voltage peak of 0.7V, and no effect on making behaviour but do delay drop out by a factor of 3 or 4 times.

Vacuum and hydrogen gas-filled relays have some significant inherent advantages in switching high current dc loads. These include:

- Long load life due to ability to use high temperature contact materials
- Low contact resistance due to the elimination of contact oxidation/contamination
- Light weight and small size due to small contacts and short contact gaps
- Low coil power due to optimized magnetic circuits and small size
- High integrity, durable ceramic to metal hermetic seals

Hermetically sealed dc relays rated at 320V, 650A dc are available for lower dc voltage power applications, for example in electric vehicles and aircraft (see section 33.14).

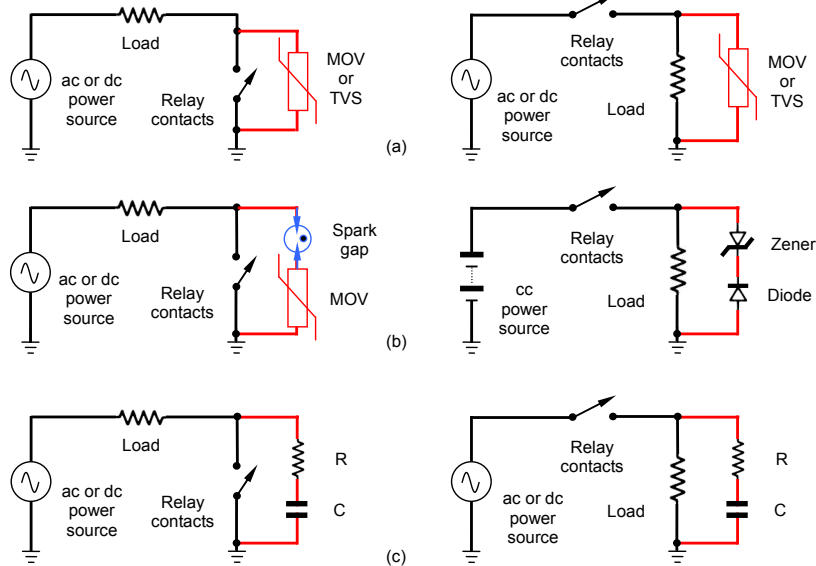

Figure 33.9. Commonly used relay contact (direct and indirect) protection circuits.

33.7 DC power switching

i. Low-voltage power relays

Relay loads are classified into four ranges. The load and voltage range definitions are:

- Dry circuit is defined by $0 \leq V \leq 30\text{mV}$ and $0 \leq I \leq 10\text{mA}$. The softening voltage U of the contact material is not reached.
- Low load $U \leq 20\text{V}$ and $I \leq 100\text{mA}$.
- Intermediate load $U \leq 50\text{V}$ and $I \leq 1\text{A}$.
- High load $U \leq 250\text{V}$ and $I \leq 1\text{A}$.

Dry circuit loads: No current is switched. The contacts carry current only after they are closed or before they are opened. The currents may be high, but are not switched. The maximum voltage applied is less than the softening voltage of the contact materials. Usually loads up to a maximum of $30\text{mV}/10\text{mA}$ are considered dry circuit loads. Since there is no arcing, contact resistance is kept low by using gold plating or gold alloy contacts. An increase in the contact resistance can only occur due to corrosion or polymerization. Switches with gas-tight housings can perform more than 200 million operations, switching dry circuit loads, without a change in contact resistance.

Low Loads: During contact break, the temperature in the constriction area increases to the melting and then boiling temperature of the contact material. Even though the open circuit voltage is lower than the minimum arc voltage, short arcs with low energy still occur due to inherent inductance and capacitance. Consequentially, carbon forms on the contacts (due to atmospheric hydrocarbons) but the arc does not have enough energy to remove the carbon. The sliding of the contact surfaces causes polymerization of the organic compounds with the result that deposits with high, unstable resistance are left on the contacts. This is a particular problem with metals of the platinum family. Typically, carbon or carbonized contacts have contact resistance between 2 and 4 Ohms. The solution is to use gold or gold alloy plating on the contacts.

Intermediate Loads: For intermediate loads, short arcs and discharges from cables are the most common effects. Current is below the minimum level for even momentary arcing when the contacts are open. Loads of 50 to 400mA at 26V are typical for this range. Some arcing can occur during the *make* or *break* of the contacts, but extinguishes itself by contact transfer completion. This arcing is

usually just enough to carbonize any organic vapours present. The carbonized material eventually deposits on the contacts and contact resistance increases, possibly leading to failure. The objective is to minimize the amount of organic vapours by the selection of insulation, potting compounds, and cleaning agents.

High Loads: Arcing Contacts. Arcing is detectable with all normal operational high loads. Typically, the voltage must be greater than 12V and the current must be more than 400mA for arcing to occur with most metals. The arcing actually serves a useful function, as it cleans the mating surfaces. Depending on the voltage and current, contact erosion or material transfer is the main switching effect. Contact materials such as silver-cadmium oxide, minimize electrical erosion at these load levels.

Mixed level switching: In different applications, monitoring the contact position in the load circuit is required. The synchronised failsafe coupling between two different contacts is realized in safety relays by applying forcibly guided contacts. For example, one contact is used to switch the load, and another is in the load circuit. The power in the load circuit depends on the application and variants between mW and kW (kVA). The control circuit is normally on the logic level of devices such as FPGAs or ASICs. A frequent issue is the separation of the contacts connected to power from those connected to the control circuit. The switching arc produces a splash of oxides and carbon particles which disperse in the area, for example, undesirably on to the contacts through which the control signal is carried.

ii. Higher-voltage power relays

Depending on the type of switching, higher-voltage power relays can be divided into two categories:

- Cold-switching of high voltages 12 to 70kV (no current during contact movement)
- Hot-switching with voltages up to 25kV (current flow, hence arcing, during contact movement)

There are two types of relays for hot-switching:

- Make only relays, with pulse currents of up to a few kilo-amperes, with durations less than a few milliseconds
- Power switching relays, for current up to 150A.

Misapplication of high voltage relays occurs most commonly in power switching applications. Since most relays are used only to isolate the load, it cannot be assumed that the rated carry current is the power switching rating.

High voltage applications (typically above 1,800V)

Make only applications - select a SF-6 gas filled relay whenever possible, since such relays are designed specifically for high voltage applications, but generally are not suitable for *breaking* a load.

Make and Break applications - select a vacuum relay that has contacts made of a material with a high melting point, such as tungsten or molybdenum. Some vacuum relays have copper contacts for high current carry applications, and are not suited for power switching.

In a vacuum relay, part of the contact material vaporizes during power switching and deposits itself on the inside walls of the relay. When this occurs, the dielectric stand-off voltage decreases (leakage current increases) with the number of power switching cycles, possibly making it unsuitable for the application. The power switching rating of a vacuum relay is therefore dependent on the power to be switched, the number of cycles, the dielectric stand-off voltage, and the maximum circuit leakage current allowed.

Medium voltage applications (typically < 1,800V)

Both vacuum and hydrogen filled relays are suitable for power switching applications at 1,800V dc and below. Vacuum relays typically have a longer life cycle rating than hydrogen filled relays, but do not carry or interrupt as much current. The most important parameter is the current the relay will be required to switch during 'abnormal' switching conditions. The relay may have to interrupt the entire current capacity of the system before a circuit breaker or fuse has time to function. An incorrectly selected relay could be vaporized during opening, resulting in electrical shorts within the system.

Whenever a relay is power switched, an arc is generated. The arc duration and the current and voltage levels are critical factors in determining relay life and reliability. Whenever a relay is required to switch a load, there are several precautions that should be taken to ensure satisfactory outcomes. These are:

1. Circuit load elements can generally be characterised as basically capacitive, inductive, or reactive, even though they may be comprised of both active (tubes and solid-state devices) and passive elements (capacitors, resistors, inductors, etc.). Circuits with capacitive or inductive elements are more difficult to switch due to the reactive stored energy. Switching these different types of loads has a specific effect on the relay voltage.

Resistive loads

Circuits primarily resistive have minimal effect upon the voltage across hv contact terminals. In resistive loads, the duration of the arc is primarily determined by the speed at which the contacts separate, as shown in Figure 33.10a. The interruption of an ac load is easier on the contacts than a dc load since the ac interrupts itself each half cycle as the current goes through zero. Resistive loads are the standard against which other load types are measured, that is, relay load switch ratings usually assume a resistive load.

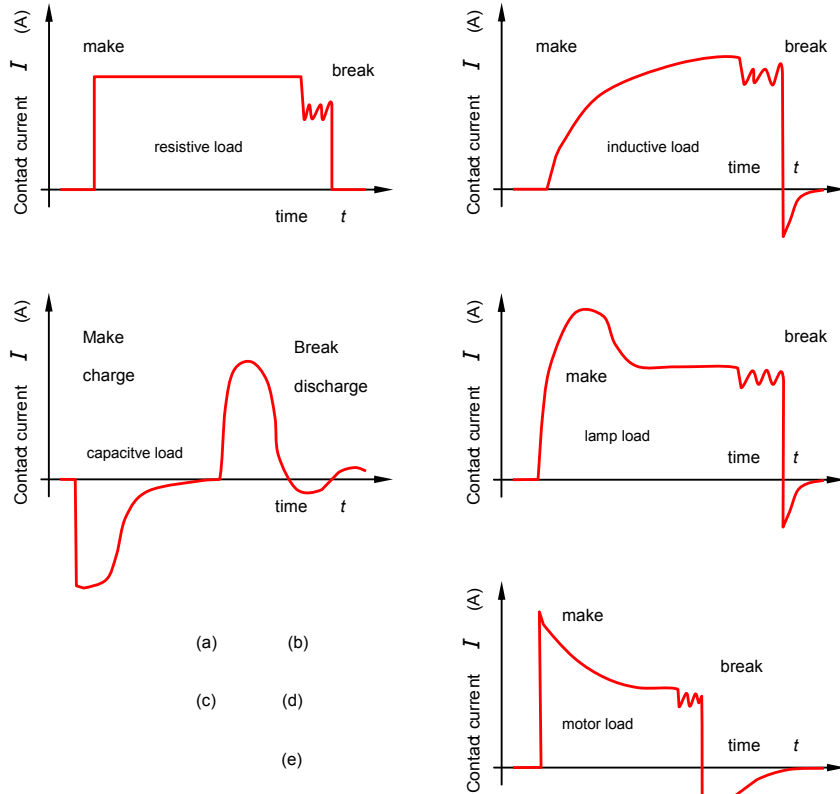

Figure 33.10. Typical load profiles: (a) resistive load; (b) inductive load; (c) capacitive load; (d) lamp load; and (e) motor load.

Inductive loads

With inductive load elements, a high momentary voltage transient occurs when the circuit current is interrupted, which decays rapidly to the open line voltage. Inductive loads in high voltage circuits can be destructive. The release of stored energy when the load current is interrupted serves to maintain the current, as shown in Figure 33.10b, and causes voltage spikes that can damage associated circuit components, including the relay. Inductive loads in ac circuits are less stressful than in dc circuits. However, in both cases, the inductive load energy should be suppressed at its source with an appropriate protective device. If the inductive load is properly clamped, it becomes, in effect, a resistive load.

Capacitive, lamp, and other high in-rush loads

When circuits with large capacitive elements break, a negative bias voltage appears due to the stored energy of the capacitor. This stored energy can cause a momentary high current surge upon contact make.

When switching on a lamp, charging, or discharging a capacitor, the inrush current may be many times the steady state current, as shown in Figure 33.10 parts c and d. The primary concern with high inrush loads is that contact bounce and associated arcing can cause the relay contacts to weld when making the load. For this reason, power-switching type relays specifically for lamp or capacitor charge or discharge applications should be used. Normally the maximum interrupt rating is used to determine the correct relay for lamp applications. SF-6 gas-filled relays are usually the choice for capacitor discharge applications. A typical contact current profile for the high inrush associated with electric motors, is shown in figure 33.10e.

2. Are voltage spikes present in the circuit? Minimal inductance can generate extremely high voltage spikes that can damage circuit components. For this reason, steps should be taken to clamp any inductance at its source.

3. Select a ground isolated relay for high voltage load switching, whenever possible. Relays which do not have an internal ground plane are known as ground isolated and when such a relay is used for load switching, the potential for ground faults is virtually eliminated. If a ground-isolated relay is not available, locate the relay on the ground side of the load, as shown in figure 33.10. Then the load will limit the fault currents in the event of an internal arc-over to ground in the relay.

Power switching applications for high-voltage relays

High-voltage power switching applications are those that require the relay to make and/or break the load - hot loads. In most applications, it is important to know the highest potential fault current to be encountered and how many times the relay or contactor will be required to clear the fault, since these specify the required relay.

Load switching in ac circuits is less stressful on the relay due to the natural arc extinction that occurs as the current periodically passes through zero. Because of this, available relay ratings are much higher for switching ac circuit loads.

Switching of direct current loads creates specific problems for relays and requires relays, contactors, and power controllers that have been specially designed to handle the arcing problems of dc switching. When load switching occurs at voltages above 1000V, the typical power switching lifetime derating curves in Figure 33.11a are applicable.

Higher current affects relay ratings more than higher voltage, and the life expectancy for double throw, DT, relays is lower due to greater contact bounce.

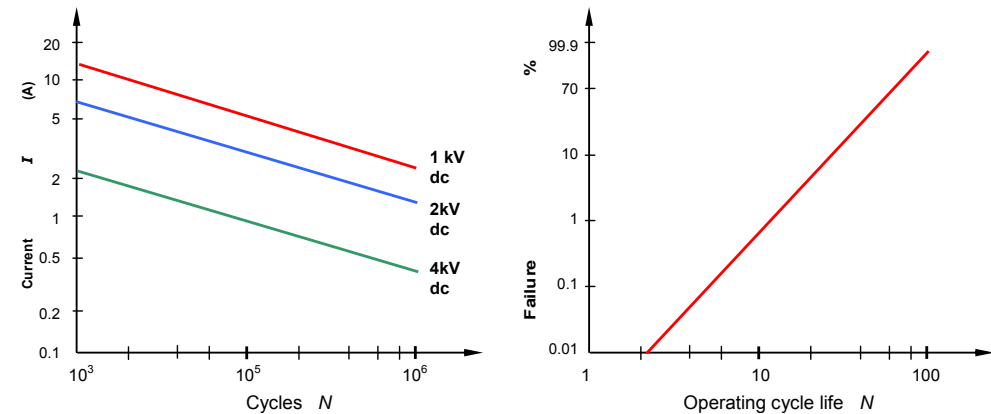

Figure 33.11. (a) Typical contactor lifetime derating with increased load switched current and (b) reliability analysis Weibull data plot of end of life failures.

Weibull plotting is used to predict product reliability. It is a simple and efficient way to predict reliability from a small number of life tests and is widely used for this purpose. The cumulative percent failure is plotted against life. The Weibull scales ($\log_e - \log_e$ scales) are designed so the failure data of a wide variety of manufactured devices will tend to lie in a straight line. As the chart in figure 33.11b shows, this data can then be interpreted to estimate the likelihood of failure at a given life.

33.8 Miniature circuit breakers

The selection of a circuit protective device requires an understanding of the potential hazards against which protection for safety is required, namely:

- electric shock (direct and indirect contact)
- thermal effects
- over-current
- under-voltage
- isolation

A Miniature Circuit Breaker (MCB), shown in figure 33.12, is a resettable electromechanical series protective device that protects against two types of over-current situations; overload and short circuit. MCBs are designed to current protect by tripping a system downstream of it, thereby preventing damage to cables and equipment. It isolates a circuit during an over-current event without the use of a fusible element. The MCB tripping mechanism is thermal-magnetic.

MCBs are installed in modern ac consumer units, and are a convenient alternative to fuses as they can be reset without having to replace wire or a fuselink, with a flick of a switch or pressing of a button. MCB ratings relate to continuous service under specified installation conditions, although cables can carry higher currents for short periods without causing permanent damage.

MCB variations are also used for earth leakage detection and protection, pole change over switching, dc operation, as well as for basic ac isolator switches, in both single and three phase 50/60Hz ac applications.

33.8.1 AC MCBs

Construction

Miniature Circuit Breakers have a precisely formed moulded case and cover of flame retardant high strength injection moulded thermoplastic polyester grey colour material having a high melting point, low water absorption (non-hygroscopic), high dielectric strength (anti-tracking) and high temperature withstand. The switching mechanism is independent, manual, quick-make, quick-break, and trip free, that is, the breaker trips internally even if the operating knob is held in the ON position.

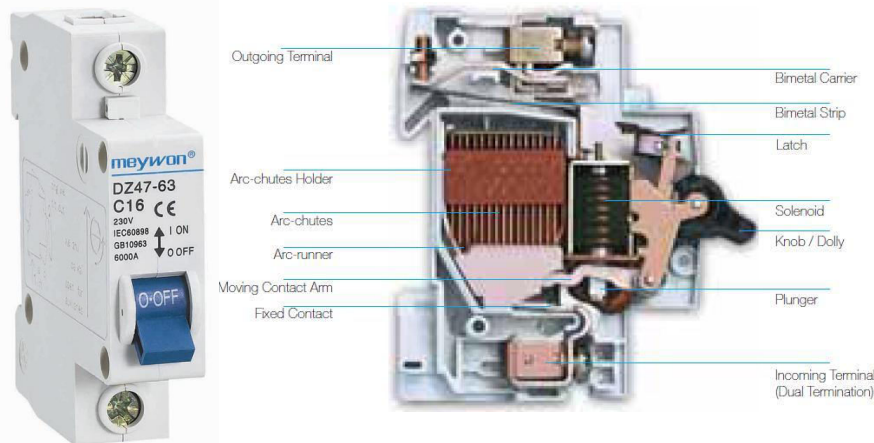

Figure 33.12. Miniature circuit breaker.

- An **actuator lever** (knob/dolly) is used to manually trip and reset the circuit breaker. Also it indicates the status of the circuit breaker, namely ON or OFF/tripped and is usually designed so it can still trip even if the lever is held or locked in the ON position. This is referred to as 'free trip' or 'positive trip' operation.
- The mechanical **contacts** allow current when touching (in contact) and break the current when moved apart. The contact mechanism comprises of fixed and moving silver-inlaid copper contacts specially designed for reliability, long life, low erosion, and anti-weld properties. The contacts have low resistance resulting in low watt loss and are designed to have zero bounce during closing operation, with an electrical service life in excess of 30,000 make/break operations.

- The **arc divider/extinguishing device** comprises a 15 plate arc chute, as seen in figure 33.12. During an overload or short circuit event, the contacts of the breaker separate and an electrical arc is formed between the contacts through interposed air. The arc under the influence of the magnetic field and arc guide is moved into the arc chute by 'running' the arc down the interior of the breaker along the arc runner. When the arc reaches the arc chute it is broken into small segmented arcs, where it is rapidly split and quenched. Thus the arc runner and arc chute limit, dissipate, and quench the arc energy during interruption of an overload or short circuit event. The segmented arcs split the overall energy level into segments of less than 25V, where each segment does not have a high enough energy level to maintain an arc whence all energy is naturally dissipated.
- A calibration screw allows the manufacturer to precisely adjust the trip current of the device after assembly.

Current limiting breakers use an electromechanical (thermal/magnetic) trip unit to open the breaker contacts during an over-current event. The thermal trip unit is temperature sensitive (bimetal device) and the magnetic trip unit (electromagnetic device) is current sensitive. Both protection units act independently and mechanically with the breaker's trip mechanism to open the breaker's contacts, that is, both components trigger the device mechanically.

i. Components and operation of the magnetic trip unit (short circuit protection)

The magnetic trip unit protects against short circuit fault currents and comprises an electromagnet and an armature, as shown in figure 33.13.

When there is a short circuit or large overload, a high magnitude current passes through the coil creating a magnetic field that attracts the movable armature, with a force proportional to the peak current, towards the fixed armature. The hammer cam trip is pushed against the movable contact whence the contacts are opened thereby interrupting the circuit current. The opening of the breakers contacts during a short circuit is complete within 1/2ms.

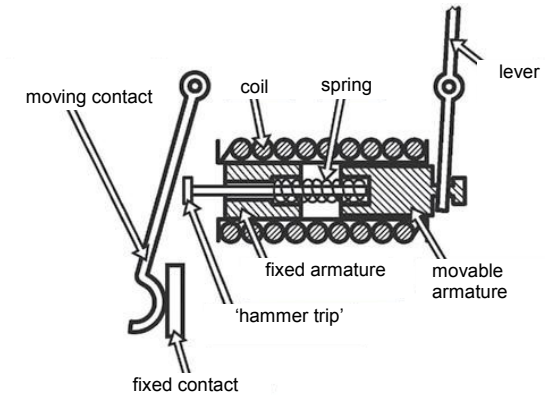

Figure 33.13. Magnetic trip unit of an MCB.

ii. Components and operation of the thermal trip unit

The thermal trip unit protects against a continuous moderate overload and is comprised of a thermo-metallic element (bimetallic strip) located behind the circuit breaker trip bar and is part of the breaker's current carrying path. When there is an overload, the increased current flow heats the bimetal causing it to bend due to differential expansion of the two dissimilar metals. As the bimetal bends it pulls the trip bar which latches open the breaker's contacts. The time required for the bimetal to bend and trip the breaker varies inversely with the current, therefore tripping time shortens as current magnitude increases.

Current overload protection is applicable to any installation, conductor, or component which can be subjected to low-magnitude but long term over-current. An over-current can be dangerous because it reduces the life of the electrical installation, conductor, and components and can present a fire risk.

Table 33.4. MCB tripping bounds.

type	Instantaneous tripping current
B	above $3 \times I_n$ up to and including $5 \times I_n$
C	above $5 \times I_n$ up to and including $10 \times I_n$
D	above $10 \times I_n$ up to and including $20 \times I_n$
K	above $8 \times I_n$ up to and including $12 \times I_n$ Protection of loads with frequent short duration (approximately 0.4s to 2s) current peaks in normal operation.
Z	above $2 \times I_n$ up to and including $3 \times I_n$ for periods in the order of tens of seconds. Protection of loads such as semiconductor devices or measuring circuits using current transformers.

MCB Standard current ratings

International Standard IEC 60898-1 and European Standard EN 60898-1 define the rated current I_n of a circuit breaker for low ac voltage distribution applications as the current that the breaker is designed to carry continuously at an ambient air temperature of 30°C. The preferred rated ac current values are 6A, 10A, 13A, 16A, 20A, 25A, 32A, 40A, 50A, 63A, 80A, and 100A. The circuit breaker is labelled with the rated current in Amperes, but without the unit symbol 'A'. The ampere value is preceded by a letter 'B', 'C' or 'D' (additionally 'K', 'S' or 'Z') that indicates the instantaneous tripping current, that is, the minimum current, expressed in terms of I_n , that causes the circuit-breaker to trip without intentional time delay (that is, in less than 100ms), with 50Hz 240/415V ac. The MCB type is usually determined by a thermal device within the MCB. All 6 MCB types use magnetic fault protection, which trips the MCB within 100ms when the overload reaches a set level, as shown in Table 33.4.

An MCB's circuit rating is given in kiloamps (kA), and this indicates the level of its ability to operate. For example a domestic MCB would normally have a 6kA fault level, whereas one used in an industrial application may need a unit with a 10kA or 16kA fault capability.

Type B ('B' Curve - short circuit release is set to $(3 - 5) \times I_n$) devices are for protection of electrical circuits with equipment that does not cause surge currents, thus are commonly used in domestic distribution circuit systems, lighting, and light commercial applications where surges are low, for instance where inrush currents may come from a small number of fluorescent fittings. Such protection includes resistive loads such as bulbs, heaters, etc. However, unwanted tripping can occur due to high arcing currents, often due to poor quality lamps, whence either a higher rating B type MCB should be used, or a type C device may be more suitable.

Type C ('C' Curve - short circuit release is set to $(5 - 10) \times I_n$) MCBs are for protection of electrical circuits with equipment that causes surge currents and are most suitable for commercial and industrial protection use, where there are inductive loads such as motors, air conditioners, etc., and/or a high number of fluorescent fittings which, when switched together may cause a high inrush current.

Type D ('D' Curve - short circuit release is set to $(10 - 20) \times I_n$) units are for protection of electrical circuits, cables, and highly inductive loads which causes high inrush or starting current, typically 12 to 15 times the thermal rated current and for more specialist industrial use, where current inrush can be high, for example with X-ray machines and transformers. They may require low earth loop impedance Z_s to achieve the operating times required.

Type Z ('Z' Curve - short circuit release is set to $(2 - 3) \times I_n$) units are for protection of semiconductor devices and voltage transformer circuits.

Type K ('K' Curve - short circuit release is set to $(8 - 12) \times I_n$) units are for protection of cables, motors, and appliances.

Contact Watt Loss

MCBs have been designed to minimize energy loss through proprietary contact configurations and reduction of hot spots, with typical losses and limits shown in Table 33.5.

Figure 33.14 shows breaker curves for the various types of MCBs. Each curve has three main characteristic operational regions:

i. Thermal Trip Unit (region one)

The first sloping region (near vertical region) of the breaker curve is a graphical representation of the tripping characteristics of the thermal trip unit. This portion of the curve is sloped due to the nature of the thermal trip unit. The trip unit bends to trip the breaker's trip bar in conjunction with a rise in amperage (temperature) over time. The faster the circuit current increases, the faster the temperature rises, the faster the thermal element will trip.

Table 33.5. MCB contact ratings.

Rated Current (A)	Maximum allowable Watt loss per pole	Typical MCB Maximum Watt loss per pole	Typical cold resistance (mΩ)	Minimum incoming fuse rating B/C/D
$I_n < 10$	3.0	1.3	12	20/32/25
$10 < I_n \leq 16$	3.5	2.3	12 - 8	32/50/63
$16 < I_n \leq 25$	4.5	2.7	8 - 4	50/50/80
$25 < I_n \leq 32$	6.0	3.2	4 - 2.5	63/100/100
$32 < I_n \leq 40$	7.5	4.0	2.5 - 2	80/100/125
$40 < I_n \leq 50$	9.0	4.5	2 - 1.8	100/100/125
$I_n = 63$	13.0	6.0	1.4	125/125/125

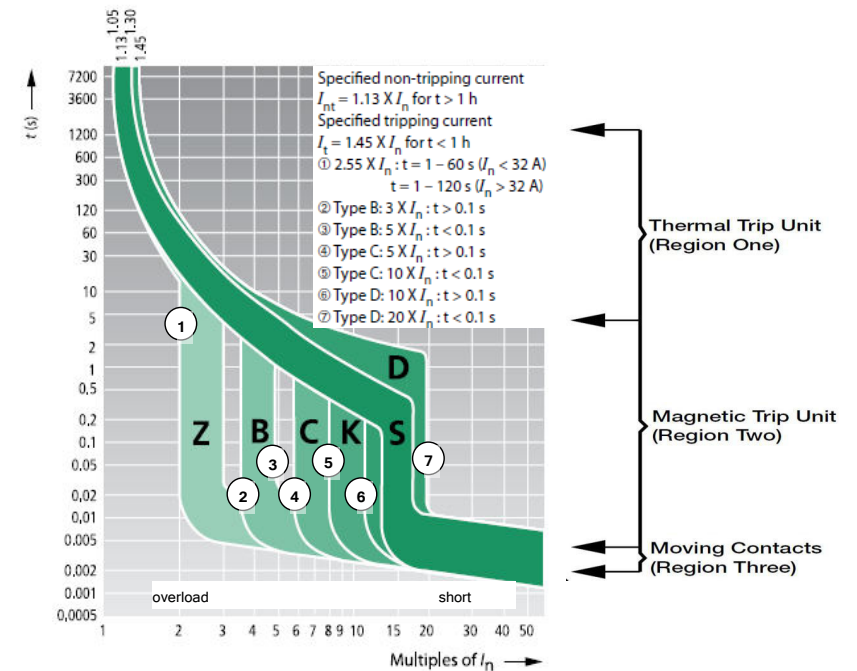

Figure 33.14. MCB characteristic curves.

Table 33.6. Thermal and magnetic current tripping boundary of different MCB types.

	Thermal Tripping			Magnetic Tripping		
	No tripping current	Tripping current	Time limits	Hold current	Trip current	Time limits
	I_1	I_2	t	I_4	I_5	t
B Curve	$1.13 \times I_n$	$1.45 \times I_n$	$\geq 1h$ $< 1h$	$3 \times I_n$	$5 \times I_n$	$\geq 0.1s$ $< 0.1s$
C Curve	$1.13 \times I_n$	$1.45 \times I_n$	$\geq 1h$ $< 1h$	$5 \times I_n$	$10 \times I_n$	$\geq 0.1s$ $< 0.1s$
D Curve	$1.13 \times I_n$	$1.45 \times I_n$	$\geq 1h$ $< 1h$	$10 \times I_n$	$20 \times I_n$	$\geq 0.1s$ $< 0.1s$
$I_3 = 2.55 \times I_n$	$1s < t < 60s$ for $I_n < 32A$ $1s < t < 120s$ for $I_n > 32A$					

ii. Magnetic Trip Unit (region two)

This region of the breaker curve is due to the instantaneous trip unit. A miniature circuit breaker's instantaneous trip unit interrupts a short circuit in 2.3 to 2.5 milliseconds. Because of this the curve has no slope and is graphically represented as a vertical straight line.

iii. Breaker Contacts (region three)

This region of the curve is the time required for the breaker contacts to begin to separate. The contacts will open in less than 1/2 millisecond and is graphically represented by the lower vertical to horizontal portion of the curve.

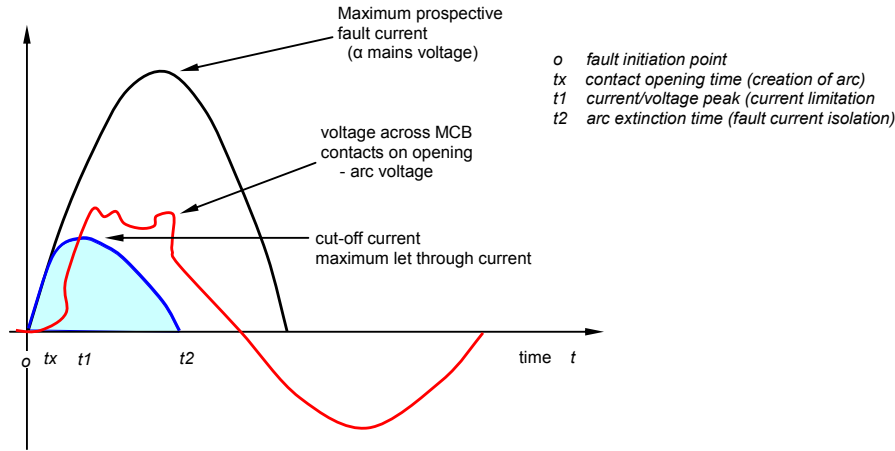

Figure 33.15. Current limiting effect of an MCB.

In equation (33.7), the nominal maximum permissible current rating of an MCB is compensated for ambient temperature, number of poles (diversity factor), and ac operating frequency according to figure 33.16 and Table 33.7.

$$I_{n_{act}} = K_1 \times K_2 \times K_f \times I_n \tag{33.7}$$

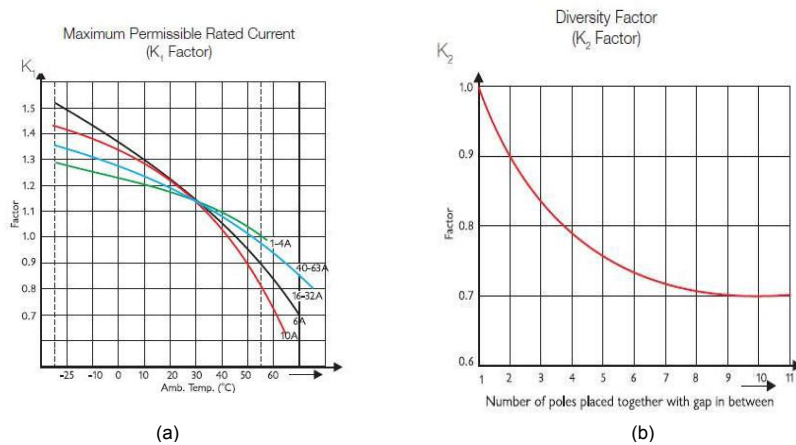

Figure 33.16. MCB derating factors: (a) ambient temperature and (b) number of poles.

Table 33.7. AC frequency derating factor, K_f .

Supply	AC				DC
Frequency	16 2/3-60Hz	100Hz	200Hz	400Hz	0Hz
Multiplication Factor, K_f	1	1.1	1.2	1.5	1.5

MCBs can be used with supply frequencies from 16 2/3 to 60 Hz without any derating. For higher frequencies, normal MCBs can be used with a multiplication factor which only affects its magnetic trip current (that is, the long term thermal trip characteristics are not affected by frequency).

Example 33.2: MCB properties

Determine the nominal current rating of MCBs in a three-phase 50Hz application with neutral switching using $I_n = 10A$, in an ambient temperature of 50°C with no gap in between breakers.

Solution

At 50Hz, no operating frequency compensation is needed. From the two parts of figure 33.16:

$$K_1 = 0.89 \text{ (from figure 33.16a, for 10A MCB at 50°C)}$$

$$K_2 = 0.78 \text{ (from figure 33.16b with } N=4\text{)}$$

Therefore from equation (33.7)

$$I_n / \text{pole} = 0.89 \times 0.78 \times 1 \times 10A = 6.94 A$$

Let Through Energy I^2t

The destructive nature of a short circuit is measured by the time it is available combined with the peak value of the short circuit, specifically the rms energy. The I^2t (Amps squared over time) value represents the amount of energy available to a network during a short circuit and is represented by the shaded area in figure 33.15, for type B and C MCBs.

During a short circuit both magnetic forces and thermal energy combine to damage devices on the series connected electrical network. The level of thermal energy and magnetic forces are directly proportional to the square of the current. The magnetic forces vary as a square of the peak current available and the thermal energy varies as a square of the rms (root mean square) current available. Current limiting breakers limit the let-through energy to a fraction (1/100th) of that available from the ac supply network.

Current limiting breakers limit the short circuit current to a relatively small magnitude in a short time, which limits a short circuit's destructive energy.

Current Limitation

When a short-circuit condition occurs, the 'ideal' current limiting circuit breaker opens before the current can reach its full potential (prospective) magnitude which occurs at 1/4 cycle (5ms). Current limiting breakers interrupt a short circuit in less than 1/8 cycle (2.3ms to 2.5ms) thereby limiting the amount of current that can reach a down-stream circuit. Limiting the available current on the circuit provides additional protection against network, breaker, or bus damage and prevents the tripping of upstream breakers, termed *selective coordination*.

Selective protective action through discrimination

Discrimination aims to ensure that only the protection device immediately upstream of a fault will trip, leaving the rest of the supply intact. If all the protection devices in a supply chain are set to blow/operate at the same threshold current, they may all trip at once if there is a short circuit. By equipping different points in the supply line with protection devices that have adjustable tripping characteristics, discrimination can be provided to localise the fault thereby minimising the disruption caused by a fault.

There are three basic approaches to discrimination.

- The first is to use devices set to trip at higher threshold currents further up the ac supply chain.
- The second is to place a time delay on circuit breakers at a higher level in the chain. By the time a fault current would cause them to trip, a circuit breaker lower down the chain should already have isolated the fault and operation elsewhere should be back to normal.
- The third approach is to discriminate on the basis of the total energy through the circuit breaker. This is related to the square of the current and time. This third approach is the best way to achieve a system that is optimised for both current rating and physical dimensions.

These objectives can be achieved by:

- Creating a difference between the trip thresholds, which is termed *current discrimination*.
- Delay - by a few tens or hundreds of milliseconds - tripping of the upstream circuit-breakers, which is termed *time discrimination*.

1 Current discrimination

Current discrimination results from the difference between the thresholds of the instantaneous or short-time delay releases of circuit-breakers in series in a circuit.

It is applied in the event of short-circuit faults and generally leads, unless associated with another type of discrimination (time or energy-based I^2t), to partial discrimination limited to the intervention threshold of the upstream device (see figure 33.17a). Discrimination is ensured if the maximum threshold of the trip unit for the downstream device D2 is less than the minimum threshold of that for the upstream device D1, including all tolerances. That is, the downstream device must have a lower continuous current rating and a lower instantaneous tripping value than the upstream device. Current discrimination increases as the difference between the continuous current ratings ΔI of the upstream and downstream devices increases.

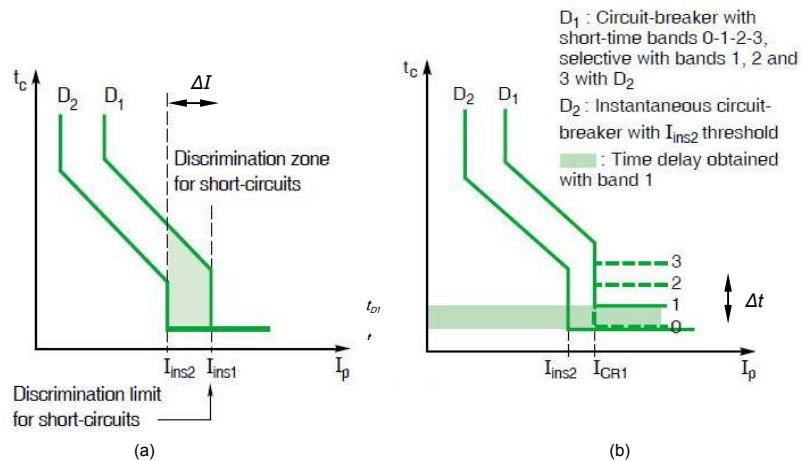

Figure 33.17. MCB discrimination types: (a) current discrimination and (b) time discrimination.

2 Time discrimination

To ensure discrimination above the short-time threshold (I_{CR1}) of the upstream device, it is possible to use a time delay, which may or may not be adjustable, on the trip unit for the upstream device, D1 in figure 33.17b.

This solution can only be used if the device can withstand the short-circuit current during this time delay. It therefore only applies to devices with high electrodynamic withstand, which is also called *selectivity*. For two circuit-breakers in series, the different time bands, when they exist, are arranged so that they discriminate between one another. The maximum operating time of one band, D2, including the breaking time, should be less than the minimum detection time of the following band, D1, $t_{D1} - t_{D2} = \Delta t$.

Short circuit discrimination

A more accurate way of checking the discrimination between two circuit protective devices at short circuit levels is to compare the energy let-through of the downstream device with the no-tripping or pre-arcing energy levels of the upstream device. The same concept applies to series connected fuses and MCBs, where the co-ordinating design I^2t data in figure 33.18a is applicable.

Pulse tripping

The nominal magnetic current rating of MCB magnetic tripping is dependant on the pulse duration, as shown in figure 33.18b, is modified according to

$$I_{hold-pulse} = K \times I_{hold} \tag{33.8}$$

Where the hold current I_4 from Table 33.6 is

$$I_{hold} = 3 \times I_n \text{ B type characteristic}$$

$$I_{hold} = 5 \times I_n \text{ C type characteristic}$$

$$I_{hold} = 10 \times I_n \text{ D type characteristic}$$

The characteristic in figure 33.18b shows that as the current pulse duration decreases, the trip current I_5 in Table 33.6 (that is K) increases.

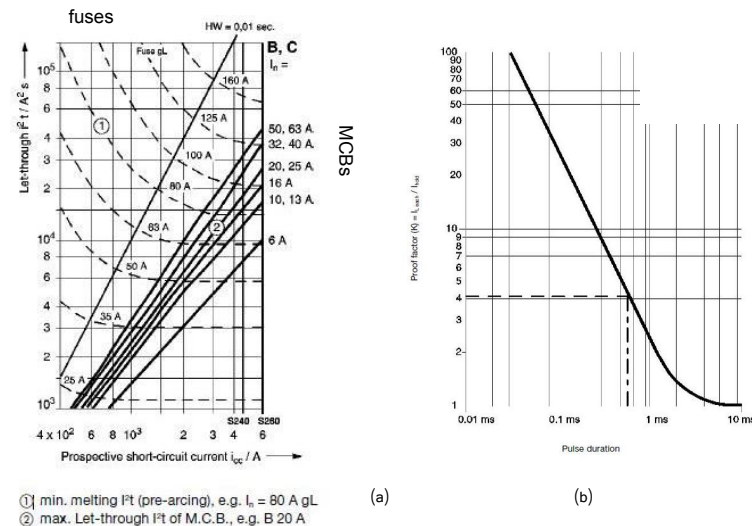

Figure 33.18. MCB: (a) I^2t let through energy and (b) pulse tripping characteristics.

Diversity Factor

Consideration should be given to the degree of circuit utilisation capacity, often referred to as *diversity*. Notwithstanding the limitations of the busbar system and the matched protection provided by the incoming device, the outgoing parallel circuits may be configured with individual circuit protection devices having an aggregate rated current capacity in excess of the rating of the incomer. The basis for this approach is that it is often reasonable to assume that not all circuits will be supplying their rated current at the same time. In this case, a *diversity factor* is used during the design stage to give an overall service capacity for the outgoing circuits. The maximum current rating divided by the diversity factor will give the maximum aggregate 'fitted' current allowed.

The use of fuses and MCBs offer certain relative features as in the following summaries.

The advantages of the MCB over fuses can be summarized as follows:

- Closed overload protection compared to HRC (high rupture capacity) fuses
- Stable tripping characteristics
- Common tripping of all the phases of a motor
- Instant re-closing of the circuit after a fault has been cleared
- Safety disconnect features for circuit isolation
- Terminal insulation for operator safety
- Ampere ratings that can be fixed and modified compared to using overrated fuses
- Reusable, hence little maintenance and replacement costs
- Lower power losses
- Simplicity of mounting and wiring
- Lower space requirements
- Provision of accessories, for example, auxiliary switch
- Stable arc interruption
- Discrimination can be achieved either based on current or time
- In a three phase power circuit, if one fuse blows, all the fuses must be replaced

The disadvantages of the MCB over fuses can be summarized as follows:

- More expensive than the fuse
- Difficult to identify where the fault occurred
- Fault can be cleared in any time up to 10 cycles of the current waveform
- Large amount of energy let through (10 times that allowed through by the fuse). A fuse can cut-off fault current well before the current reaches its first peak, hence, lower energy let through I^2t and discrimination easily achievable due to the low cut-off value

33.8.2 DC MCBs

MCBs for dc application have the same features as ac MCBs with additional features making them suitable for dc circuits. MCBs for dc application are specially designed to meet tough arc quenching conditions.

DC MCB features:

- dc MCBs incorporate a built in permanent magnet, which directs the arc into the arc quenching chamber.
- time constant $> 5\text{ms}$.

The rating and normal operating temperature of the MCB are unaffected by dc. The MCB can be selected using the thermal section of the standard time / current curves. Magnetic tripping on dc is different from the equivalent ac by a peak factor of 1.4, that is

for a 'B' curve ac MCB, magnetic range = $(3 - 5) \times I_n$

for a dc MCB, magnetic range = $1.4 \times (3 - 5) \times I_n = (4 - 7) \times I_n$

for a 'C' curve ac MCB, magnetic range = $(5 - 10) \times I_n$

for a dc MCB, magnetic range = $1.4 \times (5 - 10) \times I_n = (7 - 14) \times I_n$

The maximum short circuit current possible on a dc system is determined by the voltage of the dc source and the total internal resistance of the source. It is given by Ohm's law:

$$I_{sc} = V_b / R_b$$

where I_{sc} is the short circuit current

V_b is the voltage of the source (for example, a 100% charged battery)

R_b is the source resistance, for example, the internal resistance of the battery cells

The circuit time constant is:

$$\tau = L/R$$

where L is the inductance of the circuit

R is the resistance of the circuit

The time constant is usually given in milliseconds. Ideally, dc circuits would be predominately resistive (that is, a short time constant), as inductive circuits produce a high back emf when the current suddenly falls, due to inductive stored energy. This tends to prolong arcing during switching operation, and so reduces contact life.

The voltage of the circuit depends upon the power supply. The lower the voltage the easier switching operations will be, although the source voltage does not affect normal MCB operation.

Contact life can be significantly increased by reducing the voltage drop across each pole. This can be achieved by wiring poles in series.

MCBs in dc applications can be used under the following typical conditions:

$L/R = 15\text{ms}$ max

Voltage 12-130V dc

Short Circuit Breaking Capacity $< 48\text{Vdc} - 10\text{kA}$, $\geq 48\text{Vdc} - 1\text{kA}$

Magnetic Release Setting $4 - 7 \times I_n$

33.8.3 Residual Current Circuit Breaker

The flow of current through electrical equipment always involves risks. Poorly insulated equipment, faulty wires, and incorrect use of an electrical device cause currents to flow through the wrong path (that is, through the insulation) to the earth. This current is called *leakage current*.

Circuit breakers do not detect leakage currents, which are dangerous for humans and livestock and if not detected and eliminated can lead to fire hazards. An RCCB (Residual Current Circuit Breaker) also known as ELCB (Earth Leakage Circuit Breaker) detects such leakage currents and disconnects the load circuits from the power source, thereby providing protection against direct and indirect contact of personnel or livestock and against fire.

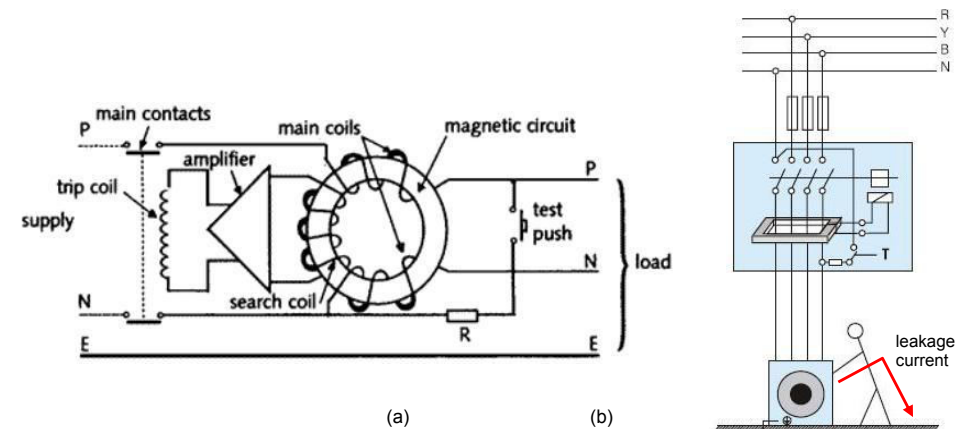

Figure 33.19. RCCB detection types: (a) single phase and (b) three phase.

As shown in figure 33.19, the RCCB is based on the principle that in an electrical circuit the incoming current (live) is the same as outgoing current (neutral), that is, the earth current is zero. An RCCB incorporates a core balance transformer having primary and secondary windings and a sensitive relay for instantaneous detection of a fault signal. The primary winding is interposed in series with the supply mains (phase-L and neutral-N) and load. The secondary winding is connected to a sensitive electromagnetic trip relay.

In a healthy faultless situation, the magnetizing effects of the current carrying L-N conductors cancel each other out. That is, the sum of the currents in the phases, is equal to the current in the neutral and the vector sum of all currents is equal to zero. Thus there is no residual core magnetic field to induce a voltage in the secondary.

If there is an insulation fault and leakage (residual) current flows to earth, the transformer primary currents do not balance and their vector sum is not equal to zero. This flow of circuit leakage current creates an imbalance in the core balanced current transformer circuit which produces a flux in the core. This flux generates an electrical signal from the secondary winding that is sensed by the relay which is tripped, thereby mechanically disconnecting the supply. The trip mechanism is operated at a residual current between 50% to 100% of its rated tripping current.

i. Protection against electrocution

A correctly chosen RCCB can detect small currents flowing to earth and reduces the risk of electrocution. The effect of electric current through human body has been well researched and the following chart summarizes the results. The necessary leakage current protection levels are implied.

Table 33.8. Earth leakage current effects on the human body

current	Effects on humans
500mA	Immediate cardiac arrest resulting in death
70 - 100mA	Cardiac fibrillation; the heart begins to vibrate and no longer beats at steady rate Irreversible condition
20 - 30mA	Muscular contraction that can cause respiratory paralysis
10mA	Muscular contraction, with the person stuck to the conductor
1 - 10mA	Prickling sensations

However, electrocution should not be viewed in terms of current alone, but in terms of *contact voltage*. A person at a certain potential gets electrocuted by coming in contact with an object that is at a different potential. The difference in potential causes the current to flow through the body.

The human body has known limits:

- voltage limit = 65V (low sensitivity) [3A, 10A, 30A]
- under normal dry conditions, voltage limit = 50V (medium sensitivity) [0.1A, 0.3A, 0.5A, 1A]
- in damp surroundings, voltage limit = 25V (high sensitivity) [6mA, 10mA, 30mA]

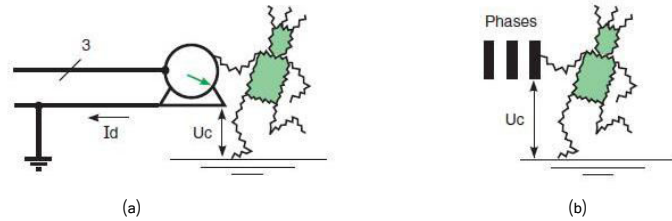

Figure 33.20. Leakage by: (a) indirect and (b) direct contact.

ii. Protection against indirect contact

If there is an insulation fault causing a short-circuit to an exposed part (conducting frame, etc. in figure 33.20a) of machinery and equipment (protection against indirect contact), the maximum permissible touch voltage *V* must occur at a residual current greater than or equal to the rated residual operating current *I* that triggers the RCCB. This condition is met by earthing the exposed part with a sufficiently low resistance to earth *R_E*.

$$\text{Earth Resistance } R_E = \frac{\text{Touch Voltage}}{\text{Rated Residual operating current}} = \frac{V_{ET}}{I_E} \quad (33.9)$$

Sensitivity application

The maximum values of *R_E* are usually specified for typical touch voltages *V_{ET}* of 25V, 50V and 65V. Over current protection devices like MCBs are unable to act promptly on small earth leakage currents. To comply with typical wiring regulations, the earth fault loop impedance in Ohms, multiplied by the rated tripping current of the RCCB in amperes must not exceed *V_{ET}*. For example, an RCCB with a rated tripping current of 30mA, with a high sensitivity detection level, the maximum permissible earth fault loop impedance is calculated as follows:

$$\hat{R}_E = \frac{V_{ET}}{I_E} = \frac{25V}{0.03A} = 833\Omega$$

Table 33.9 Fault loop impedances for different detection sensitivity levels

RCCB rated tripping current	Maximum permissible earth fault loop impedance, Ohms		
	<i>V_{ET}</i> = 25V	<i>V_{ET}</i> = 50V	<i>V_{ET}</i> = 65V
10mA	2500	5000	6500
30mA	833	1667	2167
100mA	250	500	650
300mA	83	167	217
1A	25	50	65
3A	8.3	16.7	21.7

Zone Physiological Effects, figure 33.21b

Zone 1: Usually no adverse reactions, but slight perception.

Zone 2: Usually no harmful physiological effects, reaction current is about ½mA and the let go current is about 10mA.

Zone 3: Usually no organic damage to be expected. Likelihood of muscular contraction and difficulty in breathing, reversible disturbances of formation and conduction of impulse in the heart and transient cardiac arrest without ventricular fibrillation increases with current magnitude and time.

Zone 4: In addition to the effects of Zone 3, probability of ventricular fibrillation increased up to 5% (curve C2) up to 50% (curve C3) and above 50% beyond curve C3. It increases with magnitude and time, and pathophysiological effects such as cardiac arrest, breathing arrest, and heavy burns may occur.

Zone 5: Area relating to residual current and time where most disturbances emanating from appliances and installed services may be found.

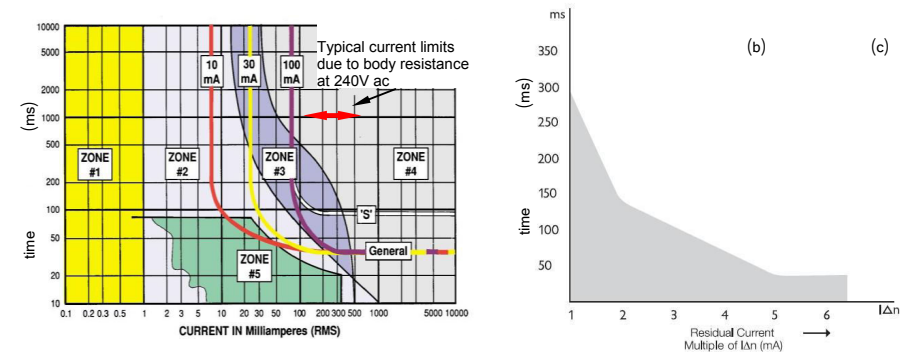
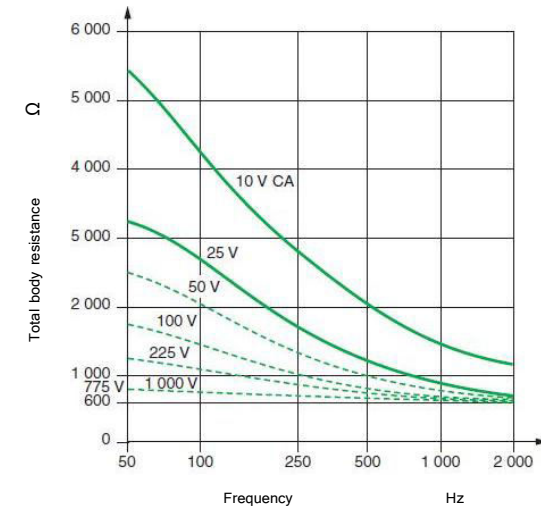

Figure 33.21. (a) Total body resistance as a function of frequency and touch voltage, (b) Shock hazard curves with superimposed RCD tripping curves and (c) MCB actuation time characteristics.

iii. Protection against fire

The majority of fires which occur as a result of faulty wiring are started by current flowing to earth. Fire can be started by a fault current of less than 1A.

RCCB sensitivity levels

RCCB - 30mA:

Electrocution in a shock hazard situation can result with a current flowing through the human body of between 80mA and 240mA, depending on the resistance of the human body and the voltage across it. To be within Zone 5 of the curve shown in figure 33.21a, it is necessary for the RCCB to operate within 50ms at 240mA and 150ms at 80mA. Both these conditions are satisfied by a 30mA RCCB.

To provide extra protection in the event of direct contact with an (unearthed) live part, extremely sensitive RCCBs with a rated residual operating current of 30mA ($I = 30\text{mA}$) or less are used. The 30mA RCCB protects against leakage currents and indirect contact with earth loop impedance up to 1667Ω . This low current level protection is necessary if:

- the insulation of totally insulated devices or their loads are damaged.
- the earth wire is interrupted
- the earth wire and live wire are transposed (accidentally thus rendering live the body of a protection class I device)
- a component which is live in normal operation is touched during repair work

An RCCB or RCCB/MCB with $I = 30\text{mA}$ is mandatory - by law in some European countries - to be used when installing machinery and equipment in areas with particularly high accident risk, viz.:

- socket-outlet power circuits in rooms with a bath or shower
- caravans, boats, and yachts and their power supply on camping or berthing sites
- electrical appliances in rooms used for medical purposes

The drawn-in switch-off characteristics of residual current devices with a rated fault current of 10mA and 30mA prevent the occurrence of the dangerous heart chamber fibrillation. For this reason, residual current circuit breakers with rated fault currents of 10mA are used for the protection of particularly exposed individual equipment. Residual current circuit breakers with 30mA rated fault current are currently specified for many areas (bath, medically utilized rooms, outside areas, agriculture, etc.) in order to ensure the protection of lives.

- Usually no reaction effects.
- Usually no harmful physiological effects.
- Usually no organic damage to be expected. Likelihood of muscular contraction and difficulty of breathing reversible disturbance of formation and conduction of impulses in the heart and transient cardiac arrest without ventricular fibrillation increase with current magnitude and time.
- In addition to the effects of Zone 3, increasing with magnitude and time, physiological effects such as cardiac arrest, breathing arrest and heavy burns may occur.

RCCB - 100mA:

A tripping current is suitable for protection against indirect contact and leakage currents for larger installations. A 100mA RCCBs operates within 30ms, but does not provide the same level of personal protection as the 30mA units. A 100mA RCCB protects against leakage currents and indirect contact with earth loop impedance up to 500Ω , although additional resistance to that of the human body in the earth path may increase this resistance. Trip levels in excess of 30mA are associated with the need to reduce nuisance tripping.

RCCB - 300mA:

For less sensitive protection suitable for large installations having high levels of leakage current, 300mA RCCBs protect against leakage current and indirect contact up to 167Ω earth loop impedance. A 300mA RCCB may be used where only fire protection is required. For example, on lighting circuits, where the risk of electric shock is small. A 300mA RCCB will not give protection against electrocution. With a 300mA residual current, the electrical energy released at the location of the earth fault is not sufficient to ignite normal building materials. With larger residual currents, the RCCB switches off the circuit in less than 200ms, thus limiting the amount of energy released to a harmless level.

Salient RCCB features

Use of special magnetic materials for the toroidal core balance transformer and a specially developed highly sensitive miniature relay ensure positive detection of earth leakage currents as low as 30mA in less than 40ms thereby acting as a life saver. All RCCBs are protected from nuisance tripping against transit voltages (lighting, line disturbances, etc.) and transient currents (from high capacitive circuits).

The moving contacts of the phases are put on a moving arm, actuated by a rugged toggle mechanism. Hence the closing and opening of all the phases occurs simultaneously. This also ensures simultaneous opening of all the contacts under automatic tripping conditions.

RCCBs incorporate a neutral configuration where the neutral makes ahead of phases and breaks after phases, which ensures complete discharge of line inductance and capacitance. The RCCB relay draws energy from the residual current needed to trip the RCCB, thus it can operate normally if the mains voltage drops out or if the neutral wire is interrupted. A relatively long period of over voltage resulting from a fault current in the mains cannot destroy the RCCB or interfere with its normal operations.

33.9 The physics of vacuum high-voltage dc relays

In terms to contact loads, understanding can make relay selection less problematic, allowing the correct selection for a given application. Table 33.10 provides a comparison that indicates the best dielectric and contact materials for specific applications.

A vacuum is an ideal dielectric. The dielectric strength of a vacuum is about 8 times greater than that of air. Since there is no oxidation in a vacuum, low resistance copper contacts (rhodium for reed relays) are used that allow the relay to carry significantly more current than traditional air exposed relays. Vacuum relays with copper contacts are termed *carry only* relays.

Since most high-voltage arcs are initiated by the ionization of the insulating medium, a hard vacuum, which, by definition, is the absence of any such media, produces the greatest possible isolation between contact electrodes. It is possible to obtain dielectric strengths of 100kV per mm contact gap in a vacuum relay. A vacuum dielectric has the additional advantage of providing an inert environment in which high-voltage contacts can operate completely oxide-free. Thus, vacuum relays typically have a contact resistance, which is lower and more stable than other relay types.

Voltage breakdown can occur even within an absolute vacuum when the contact material itself becomes the source of ionized material to support an arc. Because (in make and break modes) soft contact materials like copper and rhodium vaporize easily as the contacts switch and deposit on the inner walls of a vacuum relay, a 'plating out' of the walls occurs over time, resulting in dielectric breakdown.

Therefore, high strength and high work function materials like refractory metals (tungsten, molybdenum, etc.) are commonly used for contacts in order to raise the electrostatic field strength necessary to cause voltage breakdown. In addition, refractory metals have high melting temperatures, which reduces contact damage from arcs and results in longer life.

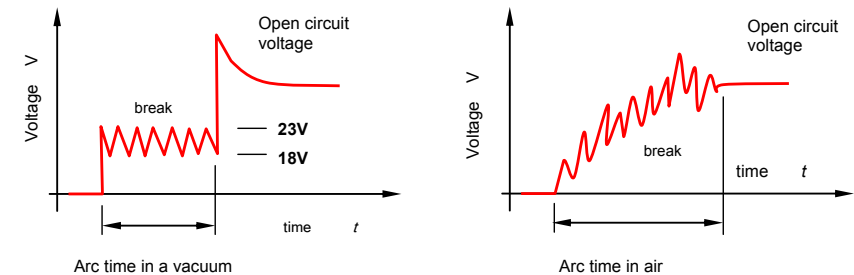

Figure 33.22. Comparison of arcs in air and a vacuum.

In load switching, an arc will always be created at the point when the contacts are close enough to allow voltage breakdown. Vacuum arcs are sustained at the relatively low voltage of 18 to 23V compared to arcs in air which are more erratic and range over a wider voltage, as seen in Figure 33.22 (The arc sustaining voltage requirement is about 300V for SF6 CBs and 500V for oil circuit breakers). Vacuum arcs tend to be more easily controlled and extinguished than arcs in air. The high-pressure region formed around a vacuum arc has a strong tendency to dissipate or blow out into the surrounding low-pressure vacuum. This phenomena, along with the ability to use contact materials like pure tungsten and molybdenum which have high melting points, means that vacuum relays and contactors typically experience much less contact erosion and have a longer life than comparable air-break devices. The resultant vacuum relays are termed *make and break*.

Table 33.10: High-voltage relay performance comparison with different dielectric and contact materials

Application	SF ₆ Gas	SF ₆ Gas	Vacuum	Vacuum
	Tungsten/Molybdenum	Copper (special applications)	Tungsten/Molybdenum	Copper
Carry Only (dc)	Good But the gas increases the contact resistance resulting in less current being carried than in vacuum	Better than hard contacts but gas increases contact resistance resulting in less current being carried than in vacuum	Good But not as much current as copper contacts	Best
Carry Only (RF)	No The gas will interfere with the RF carry capabilities	No The gas will interfere with the RF carry capabilities	Good But not as much current as copper contacts	Best
Make and Break	Good for make but only low currents on break	Good for make but only low currents on break	Best	Fair Extremely low currents only
Make Only	Best	Better But not as good as hard contacts	Good But not as much current as copper contacts	Fair Extremely low currents only
Long periods of on-use or where Low and stable leakage current is needed	Best Only relays termed 'Make only'	Better than hard contacts but the gas increases the contact resistance resulting in less current being carried than in vacuum	Good Generally will 'burp' when HV is applied	Good Generally will 'burp' when HV is applied

33.10 Gas filled relays

33.10.1 SF₆ as a dielectric

Some relays contain a proprietary gas mixture consisting of, mainly, sulphur hexafluoride SF₆ at several atmospheres of pressure. Pressurized sulphur hexafluoride has good insulating qualities and comes close to achieving the same standoff voltage as a vacuum. These gas-filled relays are usually recommended when an application involves changing or discharging a capacitor especially when the voltage is greater than 1kV. SF₆ under pressure has many advantages over a vacuum because the leakage current is stable over long periods of non-operation and because of the way the gas performs during switching. SF₆ is an excellent insulator but when the relay is switched, ionization of the gas causes electrical continuity to occur before mechanical continuity is achieved. If the relay bounces the SF₆ readily ionizes and carries the arc current. This makes the relay electronically bounceless and dramatically reduces contact wear, which contributes to the long life that these relays exhibit in capacitive make and break applications, and reduces electrical noise during switching. These SF₆ gas filled relays with hard contact materials are termed *make only* relays. However, this tendency to ionize makes gas-filled relays unsuitable for applications which require interruption of a load current.

There are two significant shortcomings to SF₆ gas-filled relays:

- Due to a film that forms on the relay contacts, SF₆ gas-filled relays have a higher and less stable contact resistance at low voltages than vacuum relays. Contact resistance is typically between ½Ω and 1½Ω when measured at 28V dc on new relays. However, even in applications up to 100V, when the current is low, higher contact resistance may occur. When low contact resistance is important, and the voltage and/or current is low, a vacuum or other type of gas filled relay should be used instead of a SF₆ gas-filled relay.
- Due to the ease with which sulphur hexafluoride ionizes, gas-filled relays cannot normally be used to interrupt loads.

SF₆ gas filled relays do not emit hazardous X-rays because the electrons collide with the gas molecules and are unable to accumulate sufficient energy to create significant radiation.

SF₆ gas filled relays are recommended for many non-RF high voltage applications. For non-RF applications and for relays over 10kV, SF₆ gas filled relays are the most forgiving of all the high voltage relays. Because they have SF₆ gas inside rather than vacuum, the leakage current is generally lower and more repeatable over long periods of non-operation. Because of the gas, they are most tolerant should the contacts have to *make* an abnormal load. If the load is not RF, first consider relays rated for *make only*.

Sealed high-voltage relay applications include high in-rush capacitive make and capacitive discharge such as found in ESD test equipment, cable test equipment, heart defibrillators, and for applications where no high voltage is applied for long periods where low and/or stable leakage current is needed. The sealing processes for vacuum relays can be used to back-filled and pressurized with SF₆ gas, *make and break* relays with hard contacts. Where the inrush is not too high and where higher carry current is required, back-filling with pressurized SF₆ gas of *carry only* relays is used.

33.10.2 Hydrogen as a dielectric

Some relays use a proprietary gas mixture consisting of, primarily hydrogen at various atmospheres of pressure. These mixtures do not have the same high dielectric and low leakage current as a vacuum or SF₆, so are not normally used for high voltage applications above 3 kV, but are ideal for dc *make and break* load switching applications. The gas mixture, combined with the use of external magnets to control the direction of the arc, cools and extinguishes the arc in a predictable manner. Because there is no oxygen in the mixture, more conductive contact materials such as copper can be used that provide the lowest possible contact resistance. The gas mixtures and magnets provide high current interrupt capabilities up to 3,500A at 320Vdc with switching capabilities as high as 1800Vdc. They also offer the ability to handle highly inductive dc load switching. Hydrogen and nitrogen gas relays are compared in Table 33.11.

Table 33.11: H₂ and N₂ gas and contact material performance comparisons for switching applications

Application	H ₂ (Hydrogen)		N ₂ (Nitrogen)	
	Contacts	Copper	Molybdenum/Copper	Copper
Carry only	Best	Good pure copper is better	Better	Fair pure copper is better
Make only life	Good Molybdenum/Copper is better	Best	Fair Molybdenum/Copper is better	Better
Make and break life	Good Molybdenum/Copper is better	Best	Fair Molybdenum/Copper is better	Better
high overload make and break	Good Molybdenum/Copper is better	Best	Fair Molybdenum/Copper is better	Better

33.11 High voltage dc relay designs

Typical high-voltage relay designs for high-voltage switching are sealed, providing rugged, small, and efficient high-voltage designs for demanding switching applications.

i. Internal hinged armature style

This traditional design approach provides high mechanical reliability and is adaptable to a number of contact configurations. The contact is actuated by the movement of the spring-loaded armature when the coil is energized. The coil assembly is external to the vacuum package and readily replaceable. When power is applied to the external coil of these relays, a magnetic field is transferred through a pole that runs through the centre of the coil to the armature, that is located inside the vacuum or gas filled sealed ceramic envelope switching chamber. The armature moves the common contact to the normally open contacts. A spring inside the sealed chamber returns the moving contact to the normally closed contact when coil voltage (specifically current) is removed.

Figure 33.23a is a typical design used in many high-current, high-voltage relays. This is a single-pole double-throw relay, SPDT. Depending on the switching application, various contact materials are used inside the sealed chamber. Tungsten/molybdenum is used for *making* or *breaking* loads. Copper contacts have lower contact resistance and are used for higher current *carry only* applications such as for RF.

Figure 33.23b shows the same design but with a built-in internal shield that extends relay life. When power switching a load using a vacuum relay, even hard contacts vaporize, and the material becomes deposited and plate-out the internal walls of the ceramic envelope. Over time, these deposits reduce the isolation voltage, which leads to the relay's end of useful life. This plate-out condition is solved by incorporating an internal metal shield as shown. The deposits hit the shield rather than the ceramic wall, resulting in a relay life many times longer than relays without the shield.

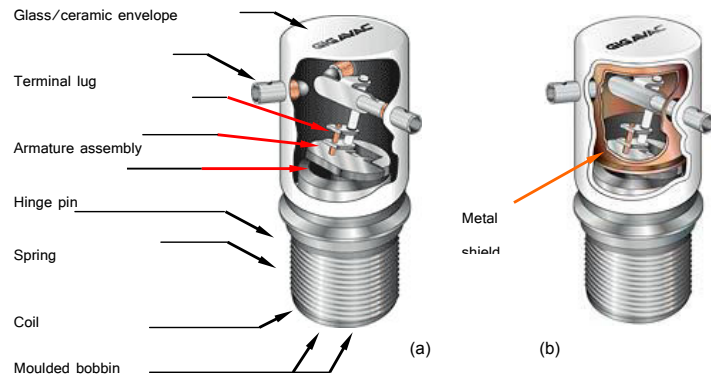

Figure 33.23. Internal hinged armature style relay: (a) double throw relay design but (b) with built-in internal copper metal shield for power switching.

ii. Diaphragm Style

This simple, low-cost design approach makes use of a thin molybdenum diaphragm that allows contact movement to be transferred into the vacuum package enclosure from the external actuating assembly. Figure 33.24 parts a and b show diaphragm style relays. The contacts are sealed in a chamber at the top of the relay. The chamber is sealed with a braze joint at the top, and with a thin molybdenum diaphragm below. The external high voltage connections are integral to the braze seal. The relay armature is below the sealed chamber as shown on the cross sectional view in figure 33.24c. When power is applied to the non-polarised coil, the armature moves, and a ceramic insulating rod that is attached to the diaphragm moves the common contact to the normally open contact (a small rod) inside the sealed chamber. Figure 33.24a is a single throw, normally open configuration, where the top contact, A3, is open and the moving contact, A2, is below.

Figure 33.24b is a double throw relay. The normally open contact is at the top, the normally closed contact is in the centre, and the moving contact is at the bottom. For this relay, the sealed chamber extends from the top of the relay down to the diaphragm that is the moving contact. Both the normally open and normally closed contacts are in a common sealed chamber.

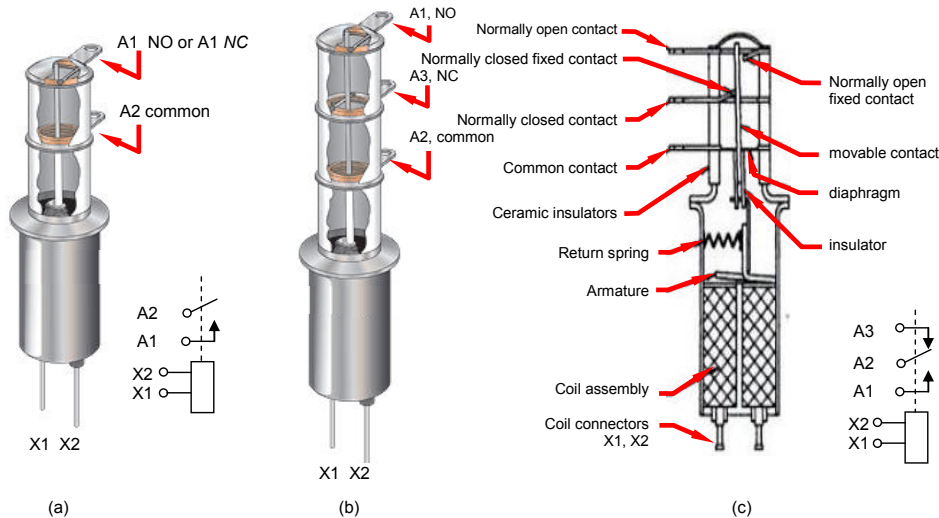

Figure 33.24. Diaphragm style single-pole relay design: (a) single throw; (b) double throw relay design; and (c) cross sectional view.

iii. Package encapsulation design

Figure 33.25 is a diaphragm style relay, where the relay in figure 33.23 or 33.24 is packaged inside a cup that provides more mounting and high voltage terminal options. Because the contacts are in a vacuum, they can withstand higher voltages than the distance between the external terminals. By potting the relay inside the cup, the high voltage capabilities are greatly improved.

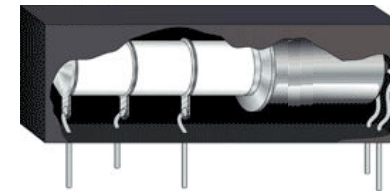

Figure 33.25. Encapsulated high-voltage dc single-pole double-throw diaphragm relay.

iv. Sealed Relay and Contactor Designs

Impervious ceramic sealing technology is a low-cost, light, rugged, high temperature, high quality hermetic seal for relays and contactors. The ceramic header is welded, without a thick layer of epoxy, to a can with high-temperature plastics inside for the arc management. The ceramic seal allows high pressure sealing for a vacuum, or hydrogen or suitable inert gases that facilitate high-current interruption. In turn, the controlled internal environment allows the use of low-resistance, high-conductivity, high contact pressure, copper contacts. Formerly, sealed relays and contactors used all ceramic envelopes which are expensive, glass to metal seals which do not provide true seals over long periods of time, or epoxy and plastic seals that do not provide the high temperature ratings or the micro-sealing needed to exploit higher performance back fill gasses. The aerospace industry has adopted 270V dc high-voltage systems and industrial applications such as solar power, fuel cells, micro-turbines, hybrid and electric vehicles, etc. also involve dc voltage systems.

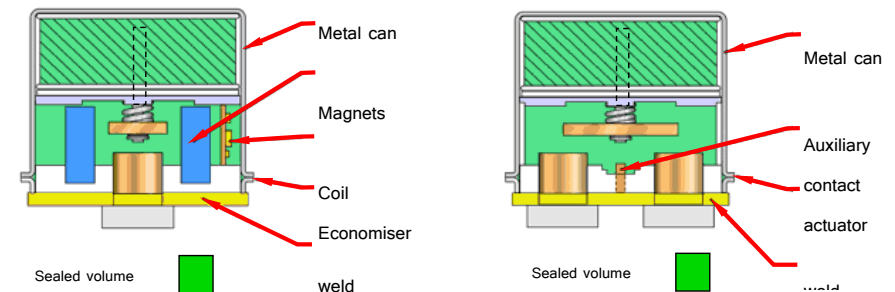

Figure 33.26. Sealed ceramic encapsulated dc relay.

v. High-Voltage dc Reed Relays

The principal function of a high voltage reed relay is to isolate a high voltage, with the use of evacuated reed switches. These are available with tungsten or rhodium contacts, depending on the switching requirements of the application. High-voltage reed relays are intended for use in dc or ac (50Hz to 60Hz) applications. (RF reed relays are not specifically considered). The reed switch consists of two ferromagnetic blades (generally composed of iron and nickel) hermetically sealed in a glass capsule, as shown in figure 33.17. The blades overlap inside the glass capsule with a gap separating them, and make contact with each other when a suitable external magnetic field is applied. The contact area on both blades is plated, welded or sputtered with a hard metal, usually tungsten for low frequency switching or rhodium or ruthenium for lower contact resistance. These hard metals potentially offer long life times if the contacts are not switched with heavy loads. The gas in the capsule is usually nitrogen or some equivalent inert gas. Some reed switches, to increase their ability to switch and standoff high voltages, exploit an internal vacuum. The reed blades act as magnetic flux conductors when exposed to an external magnetic field from either a permanent magnet or an electromagnetic coil. Poles of opposite polarity are created and the contacts close when the magnetic force exceeds the retarding spring force of the reed blades. As the external magnetic field is reduced, the force between the reeds falls below the restoring force of the reed blades, so the contacts open.

The common blade (or armature blade), the only moving reed blade, is connected to the normally closed blade in the absence of a magnetic field. When a magnetic field of sufficient strength is present, the common blade is attracted to the normally open blade. The normally open and normally closed blades always remain stationary. All three reed blades are ferromagnetic; however, the contact area of the normally closed contact is a non-magnetic metal which has been welded to the ferromagnetic blade. When exposed to a magnetic field, both the fixed reeds assume the same polarity, which is opposite that of the armature. The non-magnetic metal interrupts the magnetic flux on the normally closed blade so that the armature experiences an un-interrupted flux path to the normally open blade, and to which it is attracted. If the attractive force is of sufficient magnitude between the normally open and armature, the contacts close.

Using the proper design and materials, placing an electrostatic shield around the reed switch internal to the coil and driving the shield, will allow coupling or transmission of small signals (nV signals or fA currents) through the relay with little or no interference. This is virtually impossible with other technologies except at high cost. Thermoelectric voltage cancellation, with two series differentially connected contacts, is necessary at low signal voltage levels.

Contact Materials – Rhodium versus Tungsten

Rhodium offers superior low contact resistance, which, coupled with copper plated reed switch technology produces low loss RF reed relays, with exceptional current carry performance. Rhodium contacts are offered for high voltage applications, where low contact resistance and good current carry performance are required, provided the switching voltage is below 1000V dc or ac peak.

Tungsten contacts are used exclusively for high voltage 15kV isolation (stand-off) reed relays, which are high voltage switching contacts able to switch voltages up to 12.5kV dc or ac peak at low current, 5A, 200W. Operate and release times are both about 2ms. Tungsten is a good general purpose switching contact material (10^9 dry switching and 10^8 , 200W switching operating lifetime, which reduces with breaking current) but a higher contact resistance, 100m Ω , means it is not suited for RF applications. Low capacitance of less than 1/2pF between contacts, is typical.

In a reed relay, the reed switch uses an electromagnetic coil for activation and is shown in its simplest form in figure 33.27. Reed relays require little power to operate and are generally gated using transistors, TTL directly or CMOS drivers. Reed relay contacts, when switched dry, (zero current closure or less than 5V @ 10mA), function well into the billions of operations.

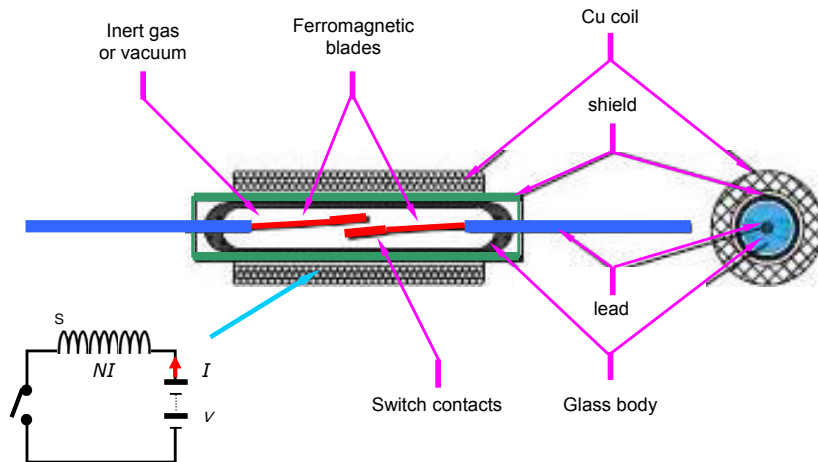

Figure 33.27. A reed relay consisting of a wound coil with a reed switch.

vi. High-Voltage Mercury relays and switches

Mercury relays are also referred to as mercury contactors, mercury relay switches, mercury wetted reed relays, mercury contactor relays, and mercury displacement relays.

A **Mercury relay** is a mercury-added product or device that opens or closes electrical contacts to effect the operation of other devices in the same or another electrical circuit.

A **Mercury switch** is a mercury-added product or device that opens or closes an electrical circuit or gas valve. This definition encompasses: mercury float switches (activated by rising or falling liquid levels),

mercury tilt switches (activated by a change in the switch position), mercury pressure switches (activated by a change in pressure), mercury temperature switches (activated by a change in temperature), and mercury flame sensors.

Internally the plunger assembly floats on a pool of mercury, as shown in figure 33.28a, hence the name, mercury relay. When the coil is activated, this assembly is magnetically drawn into this pool displacing the mercury to make contact with an internal electrode (in the case of a normally open relay) thereby connecting the external circuit that is connected to the two load terminals.

Construction

Contactors are hermetically sealed with high quality glass to metal seals. The stainless steel tube is totally encapsulated in high grade safe epoxy to prevent moisture damage and voltage breakdown through the protective coating.

The coils are wound on compact nylon bobbins and moulded onto the metal tube to provide minimum power loss. This allows for a low coil power to actuate the contactor. This also enables the units to handle high loads with minimum derating due to higher ambient temperatures. Inert gases (usually hydrogen) internally prevent excessive arcing between the mercury and the electrodes thus enabling the assembly to function for millions of cycles with low contact resistance, and minimum deterioration of the internal parts.

In multiple pole units, each tube is actuated by its own coil. This eliminates pull-in variation between contact tubes, thereby assuring consistent switching.

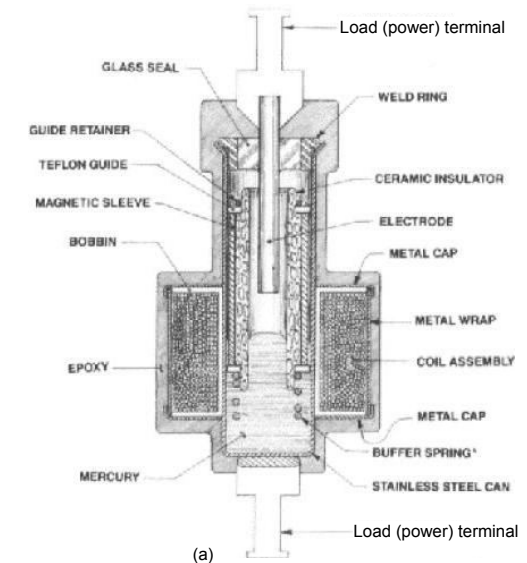

(a)

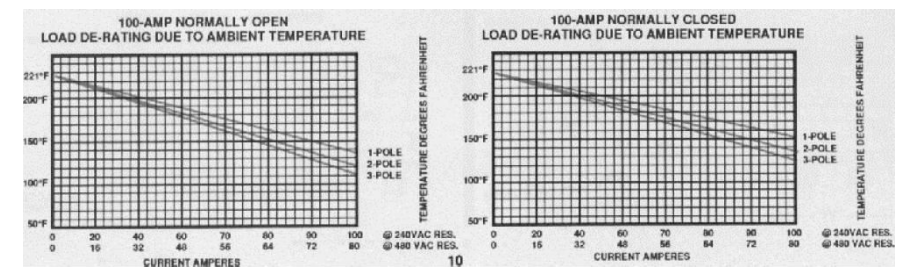

(b)

Figure 33.28. A mercury relay consisting of a wound coil with a mercury pool switch: (a) construction and (b) NO and NC, current rating dependence on temperature and voltage.

Mercury relays are vertically mounted position sensitive devices that are bounce free and can operate in high ambient temperatures. They are ideal for magnetic ballast, capacitor power supplies, UV lamp circuits, and various other medium voltage applications. Operating power levels vary from 15kV ac, 15A to 100A at 250V ac inductive power factor 0.7 or greater. Typical performance characteristics are shown in figure 33.28b and Table 33.12.

Table 33.12: Typical mercury relay contact specification

Typical Specifications		100A contacts
On Normally Open units	Operate time	50 ms
	Release time	80 ms
On Normally Closed units	Operate time	45 ms
	Release time	60 ms
contact resistance		1 mΩ
dielectric withstand		2500 Vac rms
longevity		> 10 ⁶ cycles
temperature range		-35°C to 85°C
ratings		Derate over 240 Vac

33.12 Contact ratings

There are two elements in establishing contact ratings for a contactor.

1 - *Contact carry-current rating* – This rating is a matter of heat dissipation. The contact carry current rating is based on four parameters:

- ambient temperature,
- heat generated because of the contact resistance,
- internal resistance of the contactor current carrying mechanisms, and
- size of the cables connected to the terminals.

By increasing the wiring diameter, removing more heat from the terminals, or if the ambient temperature is reduced, the more current that can be carried. The maximum allowable terminal temperature is important, otherwise there is no indication of how hot the terminals and connecting wire may get. It is needed to select compatible wire insulation, and to determine how much heat the contactor may dissipate in a sealed enclosure. Worst case, an applied current could exceed the contactor terminal rating, causing melt down of the contactor, leading to an electrical short or possibly fire.

2- *Power switching rating* – This rating is determined by contact wear and the resultant loss of dielectric withstanding voltage or insulation resistance, caused by the depositing of vaporized contact material near the contacts.

The ability of a vacuum relay to switch both resistive and inductive loads greatly simplifies power circuit design. In power switching applications, non-isolated relays (which includes all relays not identified as ground isolated) must be used with caution when the relay mounting is at ground potential and the circuit to be switched is at a high potential. Fault conditions may cause internal arc over to the grounded housing. Ground isolated relays can be used within their voltage ratings without concern for ground faults because the switching part of the relay is completely isolated from ground.

Vacuum relay versions are designed to be switched *hot* or *cold*.

Hot switching often entails contact arcing upon opening and during contact bounce. AC and dc circuits have extra considerations when switched 'hot'.

Cold switching is where the circuit is switched with no load through the relay terminals, so the relay acts either as an insulator or a conductor.

In the *make* mode the contacts conduct the full load current, and contact current handling capacity is limited by heating due to the contact resistance. Special low resistance copper alloys are used for most cold switching relays to assure high current handling capabilities.

In the *break* mode, the relay must perform as a high voltage insulator. Stand-off voltages are highest at dc and low ac frequencies, and reduce at higher frequencies due to RF heating of the insulator. Ceramic insulators provide the best withstand capabilities for high RF applications.

Many dc applications involve controllers or inverters that have large dc capacitors across the dc link. Unless these capacitors are pre-charged, the contactor essentially experiences undefined current when the contacts first close, limited only by the internal resistance and stray inductance of the system. If there is no pre-charge of the capacitor, the contacts can weld on the first or second cycle. The difference in expected life rating with a pre-charge of 90% and 80%, is a factor of 100. If possible or appropriate, an ac contactor should be used on the three-phase ac input to any rectifier stage, thereby avoiding the need for less robust dc relay technology.

33.13 High voltage relay grounding

It is normal practice to ground the base of all high voltage relays for electrical safety.

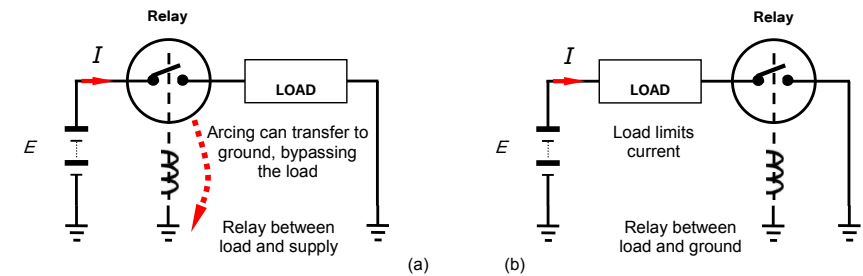

Figure 33.29. Contact position relative the load and dc source: (a) relay arcing shorting source to ground and (b) any relay arc draws controlled current through the load from the source.

The topological position of a relay in a series circuit can determine its maximum capabilities. For example, a relay with an internal ground plane within the vacuum envelope will break much more power when one contact is at ground than when the contacts are between the dc power supply and load, as shown in the two parts of figure 33.29. When a *hot* circuit is switched, an arc is usually created. This arc can transfer to ground when a relay with internal grounding is placed between the load and the power supply as in figure 33.29a. This ground fault or breakdown results from ionized gas and vaporized metal from the contacts that bypass the load and conducts between the high voltage lead and the ground plane of the actuator. The only limit to the resultant current surge is the inherent current limitation of the dc power supply itself. When one contact is at ground potential, however, the series load limits the surge current, as shown in figure 33.29b. To eliminate this type of breakdown problem, relays with ground isolation from the vacuum enclosures should be used. Vacuum relays operated *cold* may be installed in any circuit location, as the relay does not interrupt power, but acts either as a low loss conductor or as a high voltage insulator.

The mentioned grounding requirements are specified by the particular relay contact style.

i. *Diaphragm style relays* need not have their base grounded. This is because there is no ground plane inside the sealed switching chamber that an arc can strike during hot switching, and because the external distance to ground, combined with the added insulation of the coil, is greater than the breakdown voltage between contacts. These relays can be used in hot switching applications on either the high-side or low-side of the load, as shown in figure 33.30.

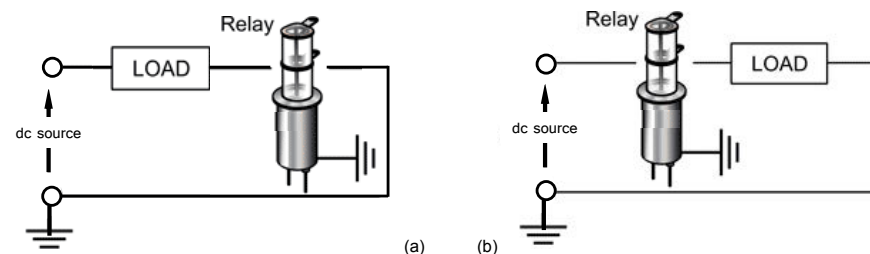

Figure 33.30. Diaphragm style relays where grounding of the case is not necessary but is recommended for safety while the contacts can be on either side of load: (a) relay on the ground-side of the load and (b) relay on the dc source-side of the ground connected load.

ii. *Internal armature style relays* must always have their relay base grounded, as shown in figure 33.31a, unless the voltage across the contacts is less than the specified dielectric voltage breakdown between the coil and case. When hot switching voltages above the coil to case dielectric voltage rating, the relay *must* be on the ground-side of the load as seen in figure 33.31a and the case *must* be

grounded. For hot switching voltages lower than the coil to case dielectric voltage rating, the relay can be on either side of the load, that is, as in figure 33.31a or figure 33.31b, and the case does not have to be grounded but is recommended to be grounded for safety.

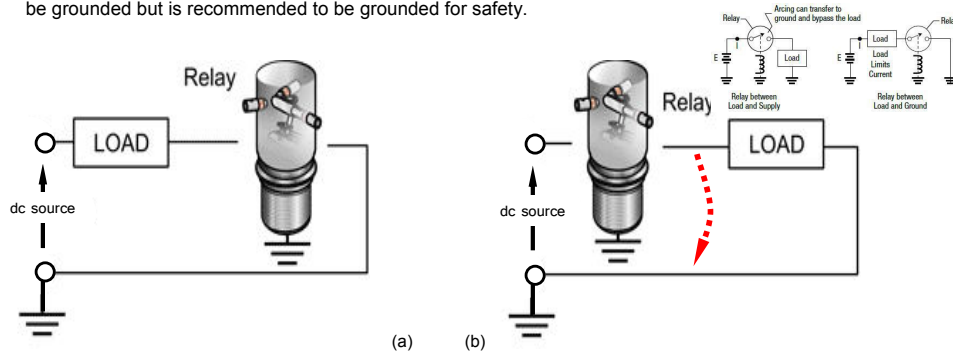

Figure 33.31. Internal armature style relays should always have their case base grounded, plus: (a) should always be on ground-side of load if the source voltage is greater than the coil to case dielectric rating and (b) on the non-ground-side of load if the source voltage is lower than the coil to case dielectric rating.

In figure 33.31a, if arcing transfers to ground, the load limits the current. In figure 33.31b (and also figure 33.30b), if arcing transfers to ground, current bypasses the relay and load, and is only controlled by the source impedance. Power control applications often must utilize figure 33.31b, although figure 33.31a is recommended for high-voltage circuit applications.

33.14 A LV voltage, 750V dc, high-current, 350A dc, make and break relay

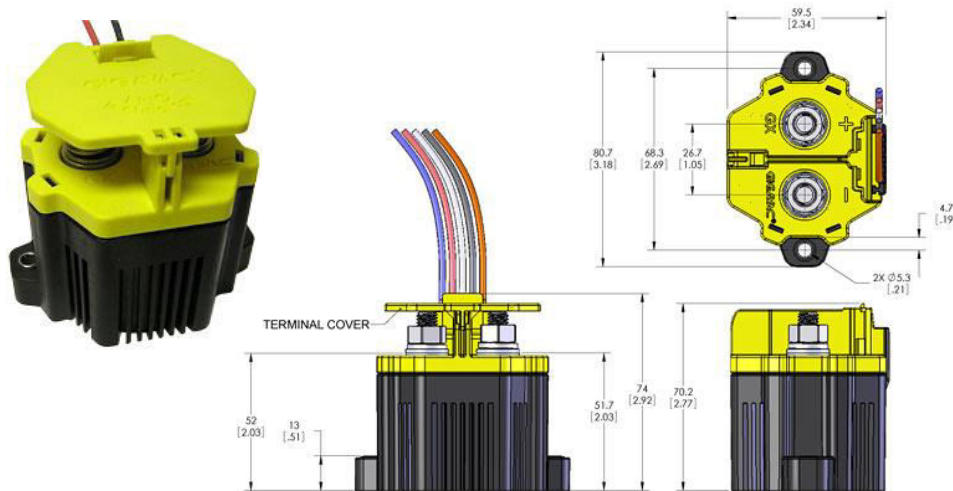

Figure 33.32. Typical 750V dc 350A dc relay.

Table 33.13: 750V dc, 350A make and break relay characteristics

Specifications	unit	value
Contact Arrangement (main)	Form X	SPST-NO
Contact Arrangement (auxiliary)	Form C	SPDT
Mechanical Life	cycles	1 million
Contact Resistance		
Maximum @ rated carry current	mΩ	0.4
Typical @ rated carry current	mΩ	0.15 to 0.3
Operate time, 25°C		
Close (includes bounce) Maximum	ms	20
Close (includes bounce) Typical	ms	13
Bounce on close, Maximum	ms	7
Release time (includes arc time at maximum break current)	ms	12
Insulation Resistance @ 500V dc	MΩ	100
Dielectric withstand voltage at sea level (leakage < 1mA)	V rms	2,500
Shock (peak) 11ms ½ sine	G	20
Vibration, Sinusoidal (80 to 2000 Hz, peak)	G	15
Storage Ambient Temperature Range	°C	-70 to +175
Mass	kg	0.44

Figure 33.32 pictures a 750V dc 350A make and break relay based on the relay construction with the features outlined in section 33.11iv. General properties are outline in Table 33.13, with make and break performance effects on lifetime shown in figure 33.33. The maximum make current is 650Adc, at which level contact welding may occur. End of life is when the insulation resistance between terminals has, that is, falls below 50MΩ @ 500V dc. Electrical life rating is based on a resistive load with 27μH maximum inductance in the circuit.

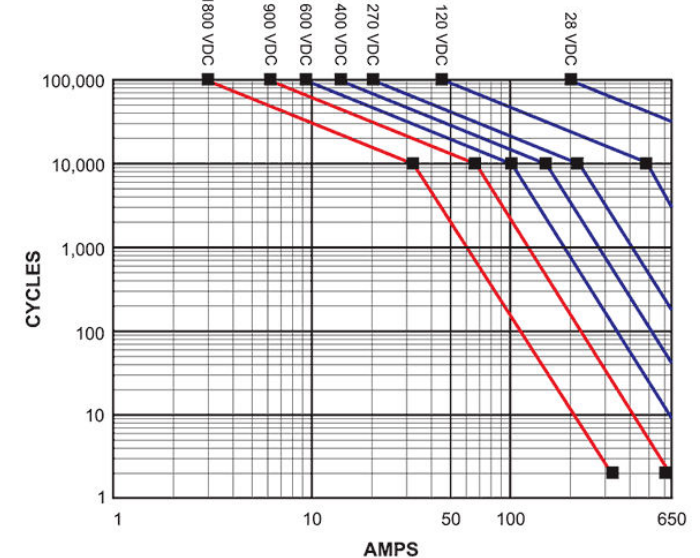

Figure 33.33. HV dc relay; upper V-I resistive load make and break limits and life cycling ratings.

With longer operating times, 85/70ms, 1000A,1500V SPST-NO relays (HX460) offer 5000 cycles at 400A/1500, 600A/1000V dc, but weigh over 4kg. Such ratings are applicable to forth coming 600-800Vdc based EV.

33.15 X-ray emissions in vacuum relays

Above 15kV, all components that operate in a vacuum, including vacuum relays, can produce X-rays that are hazardous. When extremely high voltages are applied, charge carriers in the electrical field are accelerated and can cause radiation when they impact on the electrodes. This is one reason for using SF₆ gas filled relays because the electrons collide with the large gas molecules and are unable to accumulate sufficient energy to create significant radiation. Gas-filled high voltage relays can be operated safely at high-voltages without any concern for X-rays.

Although many relays rated for use above 15 kV are gas-filled relays, when vacuum relays are used over 15kV, the equipment should be shielded with lead Pb that is at least 1.6mm thick. If shielding is not possible, then appropriate X-ray warnings should be labelled and a radiation X-ray monitoring and recording programme should be implemented.

33.16 Power reconstitution conservation method



Vacuum relays may show signs of 'gassiness' after a relatively short period of non-use. A trace of gas released from an adsorbed state on the relay internal surface is usually responsible. This trace can normally be eliminated by the use of a high voltage processing procedure.

High-voltage process procedure is as follows:

- Connect a variable high voltage ac or dc power supply in series with a 10M Ω resistor, a micro-ammeter, and the relay normally open contacts (with the relay on the ground-side of the supply).
- Immerse the relay in a dielectric fluid, such as transformer oil, but Fluorinert FC-77 is cleaner since it evaporates quickly from the relay surface.
- Raise the source voltage slowly. If the peak voltage is made equal to the maximum specified test voltage and less than 5 μ A of current is drawn (or no glow is visible in a darkened room), then the vacuum is *hard* and no reconstituting processing is necessary.
- If a glow occurs at a lower than maximum specified test voltage, hold the voltage just above the glow initiation level until the glow disappears; raise the voltage again to the onset of glow, or until the maximum specified test voltage is reached. If a dc supply is used, reverse the polarity and repeat the process.

Processing is up to 20% above the maximum specified test voltage. Typical processing times range from one minute to several minutes for high-voltage relays. It is not necessary to high-voltage process gas-filled relays.

Table 33.14: Range of available high-voltage dc relays

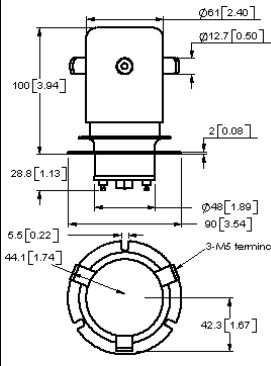
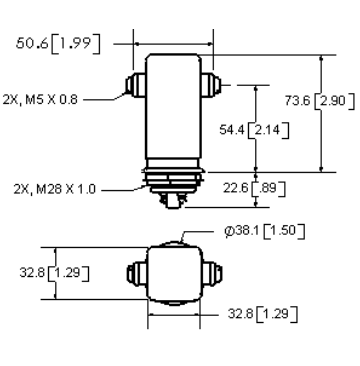
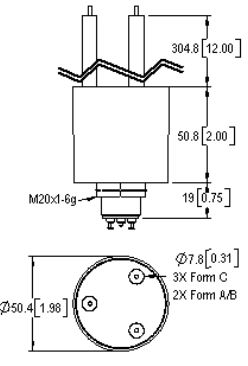
	25kV @ 150A	28kV @ 110A	70kV @ 10A
	Make and break, hot	Carry only (no load switching), RF	Make only, capacitor charging and discharging, with high inrush
			
			
	Ceramic, vacuum dielectric, tungsten	Ceramic, vacuum dielectric, Cu	gas filled, SF ₆
	SPDT	SPST NO / NC	SPST NO / NC, STDT, Latching
I_{c-b}	15 μ A	15 μ A	15 μ A
DC or 60 Hz	25kV,150A	28kV,110A / 25kV,55A	dc 70kV,10A
2.5 MHz	15kV,120A	22kV,60A / 22kV,30A	60Hz 30kV,10A
Coil hi-pot	500V rms @ 60Hz	500V rms @ 60Hz	500V rms @ 60Hz
C_{c-c}	5pF	2.5pF	-
C_{c-gnd}	5pF	2.5pF	-
R_{c-c}	3m Ω	5m Ω / 10m Ω	2m Ω
t_{op}	100ms	18ms / 18ms	20ms
t_{rel}	15ms	10ms / 20ms	15ms
life	1,000,000 cycles	2,000,000 cycles	500,000 cycles
mass	1kg	0.342kg	0.336kg
T_{op}	-55°C to +125°C	-55°C to +125°C	-50°C to +85°C
	G52 (H-25:- 50kV,10A, 25m Ω 60ms / 60ms, +85°C)	KC20 / KC30	K70A/B/C G71L

33.17 MV AC vacuum interrupts for contactor, switch, and circuit-breaker application

Vacuum interrupters with a contact gap of up to 7mm exhibit higher dielectric strength than SF₆. Wider contact gaps have a higher dielectric strength when SF₆ is used as the medium.

At 16mm (corresponding to the distance between contacts in a 36kV vacuum circuit breaker), the measured dielectric strength is approximately 200kV, as shown in figure 33.34. This is slightly higher than the rated lightning impulse withstand voltage of a standard 38kV breaker. For higher system voltages, therefore, two or more vacuum interrupters would have to be connected in series, which is marginally economical. Therefore SF₆ circuit breakers are typically used at voltages higher than 72.5kV.

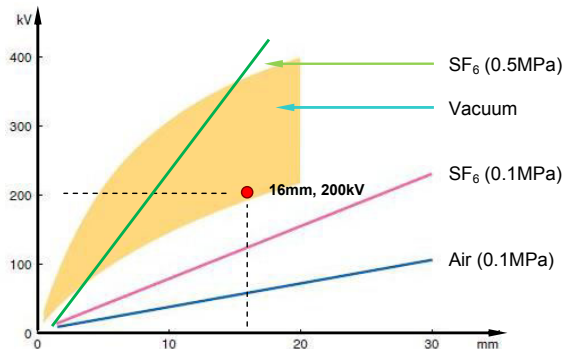
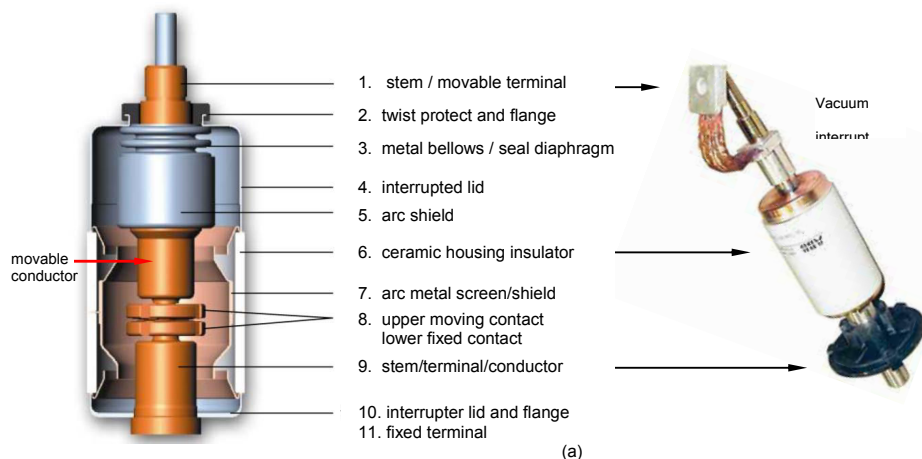
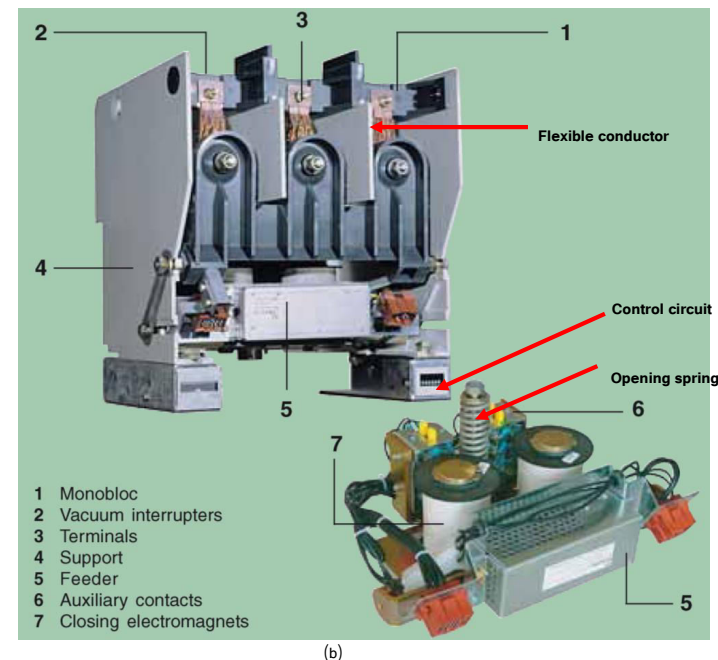

Figure 33.34. Dielectric strength comparison between different medium, breakdown voltage versus gap (inter-electrode) distance.

Medium voltage contactors are apparatus suitable for operating in ac power applications. The contactors in figure 33.35b consist of a moulded resin monobloc containing vacuum interrupter Al₂O₃ ceramic modules, figure 33.35a, moving parts, electromagnet, the multi-voltage control feeder, and auxiliary accessories. The monobloc is the support for the assembly of the fuse-holder frame. Closing of the main contacts is carried out by means of the control electromagnet. Opening is affected by means of a special counteracting spring.



(a)



(b)

Figure 33.35. Typical three-phase ac vacuum circuit breaker: (a) vacuum interrupter and (b) MV mechanical three phase contactor. (source: www.ABB.com).

33.17.1 Basic interruption principle

To ensure minimum maintenance and long life, the main contacts of the contactor operate inside the sealed vacuum interrupters (with a vacuum level of 13×10^{-5} Pa).

On opening, there is rapid separation of the fixed and moving contacts in each contactor interrupter in a three-phase contactor. Overheating of the contacts - melting, generated the instant they separate, causes the formation of metallic vapours at the point of final contact which allows an electric arc to be sustained up to the first zero current instant associated with the ac supply. At zero current, cooling of the metallic vapours allows recovery of high dielectric rigidity able to withstand high values of return voltage. The contacts of the interrupters for contactors are made of WCAg alloy or more commonly used CuCr alloy (or also previously CuBi alloy). The hard-metal component, tungsten carbide WC, makes the contacts resistant to erosion caused by arcing. As a result, contacts have an electrical lifetime of several hundred thousand switching cycles at rated current. Also, with WCAg the chopping current (minimum current, like thyristor holding current) is in the region of $\frac{1}{2}A$, compared with 3 to 5 A for CuCr and 14 to 20A for Cu, which are used widely in circuit-breakers, disconnectors, etc.

In motor switching versions, the value of the commutated current is less than $\frac{1}{2}A$ with extremely limited over-voltage, termed transient recovery voltage TRV. This transient voltage is produced because the chopping current falls to zero with a high di/dt , resulting in high voltages across stray inductances, and resonances with capacitance across the contact gap. Importantly, high-speed interruption reduces the level of fault damage to equipment.

These interrupter components give high dielectric strength and rapid recovery after arc extinction. This high dielectric strength exhibits moderately low arc energy during high current interruption, thus minimizing contact erosion. The vacuum medium provides quick controlled arc extinction due to high velocity radial diffusion of vaporized special metal alloy contact surfaces during contact separation. This allows rapid recovery of dielectric strength and minimizes over-voltages. The interruption capability is not affected by adverse conditions such as altitude, extreme temperature or humidity.

When the current is small and the contact area is large, the arc spreads by itself, and interruption should be successful. If the current to be interrupted increases, on interruption the arc area contracts and remains stationary at a certain point. Therefore an arc control mechanical structure is used, above about

10kA, to increase interruption capacity. Two basic structures are used. Spiral contacts generate a radial magnetic force, RMF, in figure 33.36a to rotate the arc, and axial magnetic field, AMF, contacts in figure 33.36b diffuse the arc by axial magnetic force.

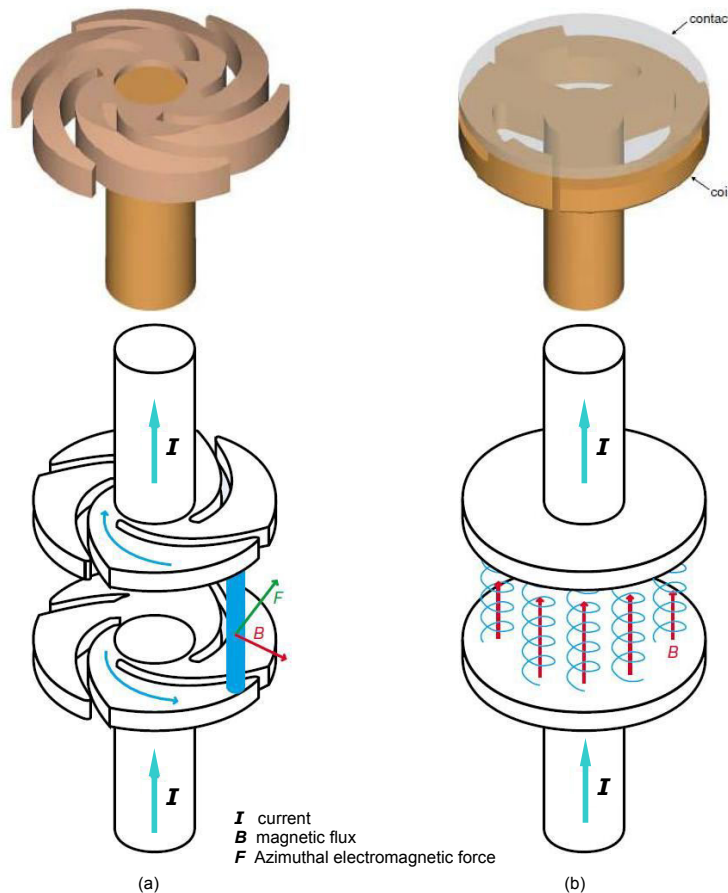

Figure 33.36. Basic mechanical contacts, with arcing operation based on: (a) a spiral contact producing a radial magnetic force, RMF and (b) slots, axial magnetic field, AMF.

i. Quadruple axial magnetic field contact – AMF

Constriction of vacuum arcs at high current levels depends on the contact material and the electrode principle. By applying a radial magnetic force/field, RMF, the constricted arc column is forced to move rapidly around the contact surface. Axial magnetic field AMF contacts within vacuum interrupters, however, prevent the vacuum arc from constricting due to the reduced charge carrier movement perpendicular to the magnetic flux and the magnetic field. This applies especially to the electrons, which have a smaller mass than the ions. The electrons gyrate around the magnetic lines of force, so that the contraction of the arc is shifted towards the higher currents. The diffused arc results in reduced energy impact on the electrodes which is also indicated by the small regular arcing voltage. Therefore, AMF contacts provide excellent high short-circuit current behaviour.

Depending on the design, the local axial field distribution is different. For single-pole arrangements the direction of the AMF is the same within the whole inter-electrode gap. For multiple-pole arrangements the polarity of the field changes. The main reason in designing AMF contact systems is to achieve an AMF distribution that uniformly spreads the thermal stress of the vacuum arc over the entire contact surface.

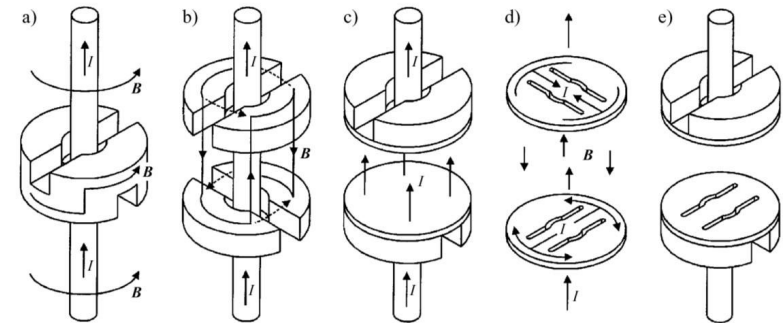

Figure 33.37. Basic principle of a quadruple axial magnetic field contact: (a) ferromagnetic circuit arrangement; (b) magnetic circuit in an open position; (c) contact system, without electrical pole face slots; (d) electrical pole face electrode slots; and (e) electrical plus magnetic combined quadrupolar contact systems.

In AMF contact designs, the magnetic field is generated by a coil arrangement behind the electrode faces. Compared to RMF spiral contacts, where the current flows directly from the stems through the electrodes in the vacuum interrupter closed position, the continuous current performance is reduced due to the increased resistance of the coil construction. The heat generated by the resistive losses are virtually all dissipated via the oxygen-free high conductivity copper stems to the outside of the vacuum interrupter. The impact of thermal radiation is minimal. The AMF is generated by a hybrid principle. The first contribution is produced by a magnetic circuit, the second by slots incorporated into the electrodes. Both AMF generating measures do not disturb the direct current flow from the copper stems through the closed electrodes. The continuous current performance is therefore comparable to RMF spiral contacts, which is of vital importance for high continuous current applications.

According to Ampere's law, the magnetic field surrounds the copper stem during current flow. By arranging four ferromagnetic pieces as shown in figure 33.37a, the magnetic flux, B is guided in the created magnetic circuit as indicated by the arrows. The magnetic flux is forced four times to penetrate the plane between the ferromagnetic pieces and perpendicular to the poles, to the current flow, I .

In the case of separating the ferromagnetic pieces as shown in figure 33.37b, the magnetic flux has to cross the gap between the ferromagnetic pieces in an axial direction four times. Due to the increasing distance between the ferromagnetic pieces in the axial direction and therefore the increased magnetic reluctance of the magnetic circuit, a part of the magnetic flux does not penetrate the gap in the axial direction. Depending on the magnetic reluctances of the different circuits, a specific part of the magnetic flux closes in the azimuthal direction as indicated in figure 33.37b by the dashed circumferential arrows. This phenomenon progressively decreases the axial magnetic flux density with increased gap distance.

Figure 33.37c shows the principle of a magnetic circuit applied to a contact system of a vacuum interrupter. After opening the electrodes in order to interrupt a current, the described quadrupolar AMF forces the arc into a diffuse mode. By incorporation of slots into the electrodes, as seen in figure 33.37d where the plates have a relative rotation of 90° , a part of the current is diverted from flowing directly through the contact plate to the vacuum arc position on the contact plate. Due to the forced diverted current loops, an auxiliary quadrupolar AMF is generated reinforcing the AMF provided by the magnetic circuit. Figure 33.37e displays the principle of the complete hybrid quadrupolar contact system. The slots of this hybrid principle impact on AMF performance. In a closed position, the dc current flow from the copper stems through the electrodes, results in a continuous current performance similar to RMF spiral electrodes. Compared to RMF spiral electrodes, additional losses are evoked by the eddy currents and the hysteresis within the ferromagnetic pieces.

The thickness of the contact plate is important in dimensioning the contact design. An increased thickness results in a weakening of the AMF, due to the increased reluctance, hence less magnetic flux penetrates the electrodes and the inter-electrode gap. Flux, leakage, is diverted through the gap between the two ferromagnetic materials behind each electrode. However, an increased plate thickness increases thermal capacity during, after, and in-between short-circuit current operation.

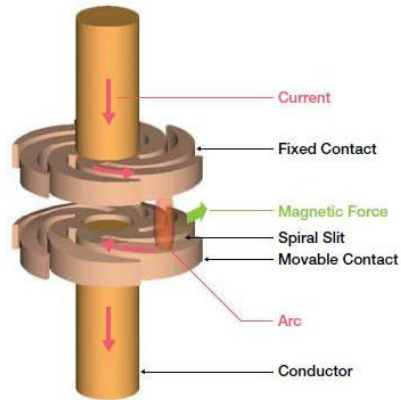





Figure 33.38. Basic principle of a spiral radial magnetic force RMF contact, showing a current filament flow during interruption.

ii. Spiral radial magnetic field contact – RMF

The spiral contacts in a vacuum generate a radial magnetic field (RMF), as shown in figures 33.36a and 33.38, which causes an azimuthal electromagnetic force to act on the contracted vacuum arc. The contracted arc moves over the contact's surface at a speed of 70 to 150 m/s. This high velocity ensures that there is less contact erosion and also significantly improves the current interrupting capability. The resultant arc voltage is higher with RMF contacts.

The advantage of the RMF contact system is its simple physical structure, while another advantage of the spiral contact is that in the closed state the current can flow through the contacts directly via the stem, thereby ensuring lower power losses for the vacuum interrupter at nominal current. In most AMF contact based contactors, the axial magnetic field is generated by a coil located behind the contacts. As a result, the resistance of the interrupter is increased and the resultant additional resistive losses reduce the nominal current performance. The only practical way in which a vacuum interrupter can dissipate the generated heat is via the copper conductors (rods), since convection is not possible in a vacuum and radiation is minimal because the larger surface areas are facing and the low emissivity of the contact metals.

In the short-circuit current range above 63kA, the more complex AMF contact system is superior to conventional RMF contacts.

Contact Structure	Flat Contact	Spiral Contact	Axial Magnetic Field Contact
Figure			
Application	VCB (General) LBS Contactor	VCB (Large capacity)	VCB (More interruption) VCB (Low surge)
Materials	Cu-Cr alloy Ag-WC alloy Cu-W alloy	Cu-Cr alloy	Cu-Cr alloy Ag-WC alloy

33.17.2 Medium-Voltage AC Vacuum circuit breaker characteristics

i. Vacuum contactors

HV contactors and relays require only a 2mm to 12mm contact opening to obtain voltage withstand of 20kV to 70kV pk (or more for series contacts) Operate times of 1 to 16 milliseconds are obtained using the simple operating mechanisms to move the lightweight contacts the short travel required.

Contact resistance is low, usually less than 10μΩ to 1mΩ (typically better than 30μΩ for a 3kA breaker), depending on the type of contact used. Higher continuous currents are also available with the use of high current shunting switches with capacities of up to 63kA. The contacts are readily adaptable to series connection for higher voltages, with a maximum operating voltage of 30kV to 45kV peak per contact, enabling withstand voltage capabilities to in excess of 300kV. A typical three-phase MV ac contactor and its key characteristics are shown in figure 33.39.

Vacuum contact mechanical life is generally at least 10,000 operations to several million operations, depending on interrupter type, speed of operation, and contact opening distance. Contact electrical life is 1 to 10 operations at maximum interrupt to several million at lower currents; and is much more dependent on closing current than on interrupt currents up to several times rated load current. Closing bounce and amp-seconds during arcing are the main electrical life determining factors.

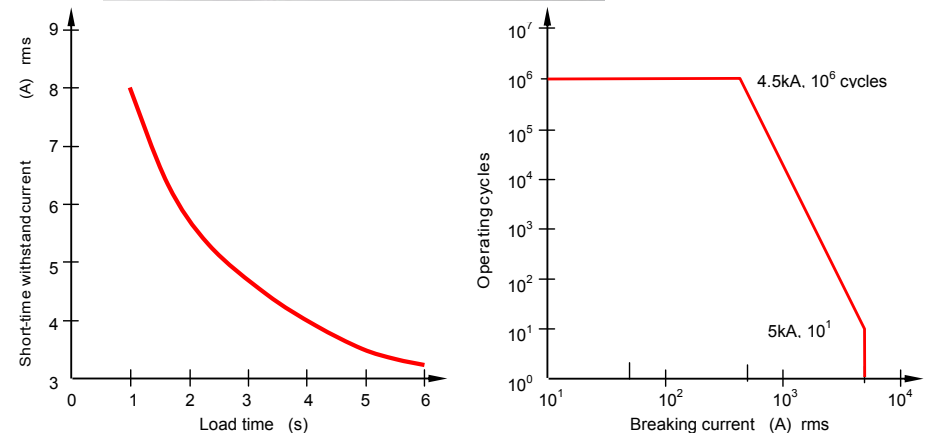
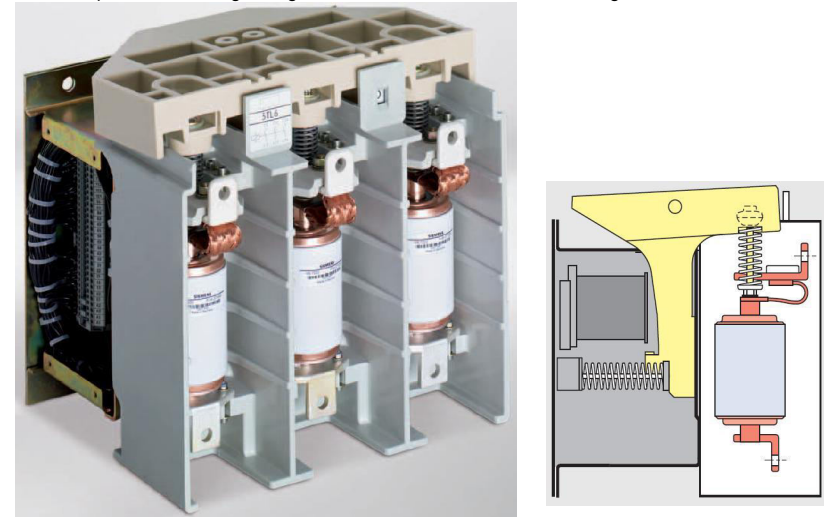

Figure 33.39. Vacuum contactor, rated voltage=12kV, rated normal current=450A, rated make current=4500A, impulse withstand voltage=75kV.

ii. Operate voltages

Single contact, normally open, normally closed, latching and trip free type HV vacuum contactors and relays are used at 208V rms to 30kV pk, and 50 to 1,200A continuous. In most standard applications, voltage ratings are raised in multiples of 30kV (operating) above 15kV (operating) by placing contacts in series. For example, two 15kV rated type contacts in series per phase are suitable for 45kV, three contacts in series per phase are suitable for 75kV applications.

iii. Current ratings

Continuous current ratings are from 50A to in excess of 1,200A rms, with up to 36kA rms continuous with the use of a shunt switch to carry the continuous current while using the vacuum interrupter's capability for the actual interruption. This switchgear has 60Hz interrupt ratings of 2kA to 28kA, 10 cycle momentary ratings of 5kA to 60kA and capacitor discharge to 1,000kA. 50Hz maximum interrupt ratings are derated 10% for 60Hz operation.

iv. AC/DC current interruption

DC: The single pole HV vacuum contactors and relays can be used on both ac and dc current interruption. The units dc rated vacuum contacts can normally be used for limited current interruption to 10A dc. Some ac rated contacts can interrupt dc at much higher currents with carefully controlled displacement pulses to create current zeros, and slow recovery voltage rates similar to those of 60Hz to 400Hz waveforms. Mechanism utilizes special tungsten contacts for limited dc current interruption. In some cases, the interruption can be carried to as high as 20 to 40A dc. When interrupting dc, transient suppression such as non-linear resistance or a capacitor in series with a 1Ω/kV inrush limiting resistor, RC snubber, should be used in parallel with the vacuum contacts and the load.

For higher dc current interruption, that is, several hundred to several thousand amps or more at 15kV dc per contact, or 40kV dc for 2 contacts in series, ac rated contactors with copper alloy vacuum contacts can be satisfactory. This is possible if multiple displacement-pulses are applied with a controlled rate of recovery voltage that approximates 60Hz current zero and recovery voltage characteristics by means of a resistor/capacitor and switching network or in combination with an inductive resonant circuit.

AC: For ac interruption, the contacts are designed with copper alloy combinations to limit current chopping to less than a 1A to 8A level to minimize switching transients. AC current interruption generally occurs at the first current zero after contact separation. If the contacts are not sufficiently apart for the rate of recovery voltage, or the arc energy is high, current may carry over to the next current zero before clearing. At higher contact voltages and currents, the contacts must not bounce after opening, which would inopportunistically temporarily reduce the contact spacing.

v. Inductive load switching

With highly inductive loads, wherever possible, transient suppressing non-linear resistance or protective capacitors should be placed across the line as close to the load equipment terminals as possible. Standard lightning arresters are not as effective as a protective shunt capacitor with approximately 1 to 2Ω/kV of inrush damping resistor in series directly connected across the load. This is essential for repeatedly switched inductive loads such as arc furnaces, motors, and many low current, transient generating inductive loads. Most switching devices create over voltages on switching and for iron core reactive loads, normal switching over voltages of 2 to 2½ times the operating voltage occur with any type of interrupter. Dry type transformers and air core inductive loads can generate higher over voltages if there is insufficient shunt capacitance.

vi. Closing and inrush currents

When closing onto transformers and other iron core inductive loads, normal inrush currents of 5 to 10 times rated load current are expected, depending on the magnetic retentivity from the previous interruption. If iron core inductive loads can be re-energized on the opposite polarity from which they were de-energized, thereby avoiding core saturation, then inrush is minimized, otherwise, it is limited primarily by the circuit and winding resistance and leakage. Repeated high inrush closing causes mechanical stress on the transformer windings as erosion of the vacuum contact (which can be over 10 times as great on closing as on interrupting even the same current). Therefore, transformers that have marginal insulation and mechanical bracing can deteriorate with repeated switching, regardless of type of switch.

vii. Contact erosion

Contact erosion and resultant internal vaporized metal deposit distribution generally determines the end of electrical life. A 2mm to 6mm of total erosion is generally the life limit. With the proper selection of contact material and with currents under 600 to 1kA, erosion should be small. At currents between 1kA and 3.5kA, erosion should be moderate. At currents approaching the maximum interruption rating, life may only be 1 to 100 operations. Even at low to moderate currents, closing generally causes 2 to 10 times more erosion as interrupting the same currents. Thus, for long-life current closing, the closing current should be limited. Step-start dual closing contactors which use inrush current limiting resistors can be used. Voltage zero and current zero sensing devices for closing or opening are viable.

viii. Actuator types and contactor configurations

Normally open, normally closed, double throw, and latching type configurations are available. Standard actuator voltages are 115V, 60Hz for smaller units, 230V, 60Hz is recommended for larger, heavy-duty solenoid actuated units. 208V, 480V, 60Hz/50Hz, 24V dc, 100/125V dc, 400Hz, and other voltages are available. Actuator voltage is specified plus the applicable HV contact operating voltage and current, basic impulse level (BIL), insulation level for MV contacts, maximum rms current interrupt, 1 cycle (16.6/20ms) momentary rms current, 10 cycle rms momentary current, or peak capacitor discharge current and the RC time constant of the current decay to 35% of peak. Other information may include type of load, number of operations per year, maximum current levels on closing and opening, speed of opening and closing, and number and type of auxiliary contacts required.

ix. Auxiliary contacts

Two auxiliary SPDT contacts are usually standard.

x. High voltage protection

Safety regulations require high voltage and line to ground current protection. In 2 to 16 ms the contactor's high speed trip, driven by a relay driver, can close the contacts and divert the fault current, or open the contacts and interrupt the load current, or both, thus minimizing damage to the controlled equipment. When proper ground fault or leakage current sensing is used, this may be fast enough to reduce accidental electrocution because of contact with one line and ground or voltages developed in the ground circuit from ground current.

xi. Uses

Basic MV contactors and relays with sealed vacuum contacts are available in single pole, two-pole, and three-pole variations. Models include normally open, normally closed, or double throw units. Latching actuators are also available. The contactors and relays are used in many high voltage power supplies for capacitor bank charging and discharging, current transfer, tap or load selection, or sealed arc interruption. The units are suited for high-speed interruption of up to 10A dc or 28kA ac. They are also reliable for high-speed crowbar or fault diversion to protect sensitive electronic devices. These various functions are accomplished with 1ms to 4ms contact closure or separation. A high-speed vacuum power interrupter can crowbar in 2ms, divert the fault, then interrupt up to its maximum rated current in approximately 3ms to 16ms, depending on type of system and current zero timing.

33.17.3 Medium-Voltage AC Vacuum circuit breaker Transient Recovery Voltage, TRV

The recovery voltage is the voltage which appears across the terminals of a pole of a circuit breaker. This voltage can be considered as two successive time intervals: one during which a transient voltage exists, followed by a second interval during which the power frequency ac voltage only exists.

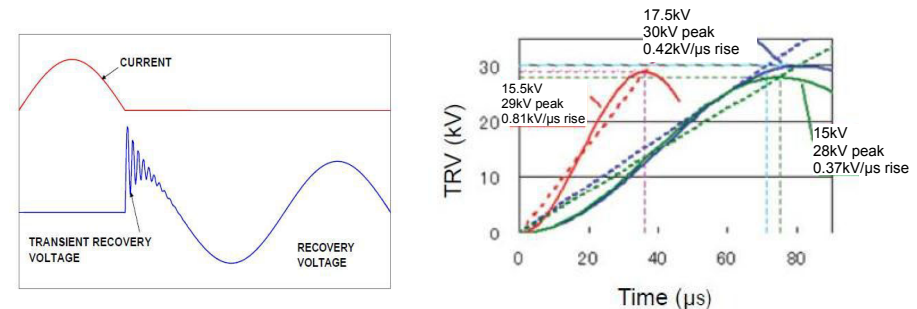

Figure 33.40. Current, TRV and Recovery Voltage and TRV waveform for 15 to 17.5kV breaker.

During the interruption process the arc rapidly loses conductivity as the instantaneous current reduces towards zero, at the chopping current level, as high as 15A for copper contacts. The current stops flowing in the circuit, but with a high di/dt from 15A to zero current. The power system response to the current interruption in conjunction with circuit inductance, generates the transient recovery voltage, TRV. The difference in the power system response voltage from the source side to the load side of the circuit breaker is the TRV.

Successful breaking occurs if the circuit breaker is able to withstand the TRV and any subsequently generated power frequency recovery voltage, which is circuit resonance at 100kHz's with the contact

gap capacitance. The TRV is then related to the power system response to the current interruption of the circuit close to a power frequency current zero. The nature of the TRV and waveforms is dependent on the impedance of the circuit being interrupted, and the distributed and lumped circuit elements.

Using superposition, the response of the load side and source side of the circuit breaker can be analyzed separately, and the time domain results subtracted. The driving voltage is the instantaneous power frequency voltage across the circuit elements at the instant of current interruption. If there is no damping, the highest peak circuit response would be twice the driving voltage.

33.17.4 Altitude derating

Insulating properties of air decrease as altitude increases. This phenomenon must be accounted for during the design stage of insulating parts of equipment that will be installed at over 1000m above sea level. In such cases, a correction coefficient is used from the graph in figure 33.41, which is calculated from:

$$k_a = e^{\frac{m \times (h-1,000)}{8150}} \quad (33.10)$$

h altitude in metres;

m value considered constant for simplification and equivalent to 1 for power frequency, lightning withstand impulse, and between phases.

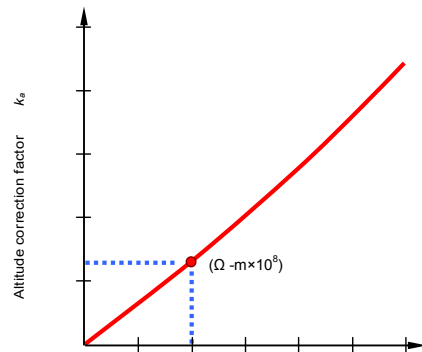

Figure 33.41. Graph for determining the voltage correction factor k_a according to the altitude.

Example 33.3: Vacuum circuit breaker altitude properties

A vacuum circuit breaker is installed at an altitude of 2000m. If it used at

- Rated voltage, 7kV
- Power frequency withstand voltage 20kV rms
- Impulse withstand voltage 50kV p

determine its necessary contactor voltage requirements.

Solution

From the graph in figure 33.41 or from equation (33.10):

$$k_a = e^{\frac{m \times (h-1,000)}{8150}} = e^{\frac{2,000-1,000}{8150}} = 1.13$$

For the above parameters, the apparatus will have to withstand the following values, based on test values at zero altitude, that is, at sea level.

Power frequency withstand voltage equal to:

$$20\text{kV} \times 1.13 = 22.6\text{kV rms}$$

Impulse withstand voltage equal to:

$$50\text{kV} \times 1.13 = 56.5\text{kV peak}$$

For installations at an altitude of 2000m above sea level, with an operating voltage of 7kV, apparatus with a rated voltage of 12kV characterized by power frequency withstand voltage of 28kV rms and with 60/75kV peak impulse withstand voltage must be used.



33.18 Corona

Corona (also known as partial discharge) is caused by the electric field next to an object exceeding the breakdown gradient for air, or whatever the field source is immersed in. Since the magnitude of the field is inversely proportional to the radius of curvature, sharper edges break down sooner. The corona initiation voltage is typically 30 kV/cm radius. Dust or water particles on the surface of the object reduce the corona starting voltage, by providing local areas of tighter curvature, and hence higher field stress.

Corona hissing or cracking can often be heard, particularly with a safely placed stethoscope or ultrasonic detector. In addition, the ozone produced by the corona can sometimes be smelt.

The presence of corona can reduce the reliability of a system by degrading insulation. While corona is a low energy process, over long periods of time, it can substantially degrade insulators, causing a system to fail due to dielectric breakdown. The effects of corona are cumulative and permanent, and failure can occur without warning. Corona can produce:

- Light
- Ultraviolet radiation
- Sound (hissing, or cracking as caused by explosive gas expansions)
- Ozone
- Nitric and various other acids
- Salts, sometimes seen as white powder deposits
- Other chemicals, depending on the insulator material
- Mechanical erosion of surfaces by ion bombardment
- Heat (although generally minimal, and primarily in the insulator)
- Carbon deposits, thereby creating a path for severe arcing

The simplest case to analyze is that of a sphere where the magnitude of the electric field at the surface of the sphere in free space is the voltage/radius. If the sphere is near another conductor, the field is no longer uniform, as the charge will redistribute itself towards an adjacent conductor, increasing the field.

Since corona is a breakdown phenomenon, it follows Paschen's law: the voltage is a function of potential difference, pd . Double all the dimensions and halve the gas pressure, and the corona voltage will be much the same.

Arcing occurs instead of corona when the voltage is too high. Corona will not form when

for Concentric Cylinders in Air:

$$R_o/R_i < 2.718$$

for Parallel Wires in Air:

$$x/r < 5.85$$

for Equal Spheres in Air:

$$x/R < 2.04$$

Arcing is difficult to avoid when $x/R < 8$

where

R_o = radius of outer concentric sphere

R_i = radius of inner concentric sphere

R = sphere radius

r = wire radius

x = distance between wires or between spheres

Corona surface factor

Table 33.15 gives empirically determined correction factors for various surface conditions. These factors are multiplied by the corona starting voltage (or field) to determine the corrected effective voltage.

Eliminating or reducing corona

Electrically, reduce or eliminate unwanted voltage transients, which can cause corona to start.

Corona can be avoided by minimizing the voltage stress and electric field gradient. Initially maximize the distance between conductors that have large voltage differentials. Use homogeneous insulators of void free solids, such as properly prepared silicone and epoxy potting materials. Smoothly radiusing of the corners of objects at high voltages relative to nearby objects will reduce the local field strength. Put the sharp corner in contact with a substance with a higher breakdown strength than air. Corona can be reduced by making the high field occur within a substance with a higher breakdown than the surrounding air.

Table 33.15: Correction factor for Corona breakdown

Condition of Conductor	m_o
New, unwashed	0.67 - 0.74
Washed with grease solvent	0.91 - 0.93
Scratch-brushed	0.88
Buffed	1.00
Dragged and dusty	0.72 - 0.75
Weathered (5 months)	0.95
Weathered at low humidity	0.92
For general design	0.87 - 0.90
7 strand concentric lay cable	0.83 - 0.87
19, 37, and 61 strand concentric lay cable	0.80 - 0.85

Covering sharp corners with an insulating film increases the corona inception voltage at the points with high E-field stress. Generically known as *corona dope*, this is an enamel or polystyrene paint or gel that can be applied. Clear acrylic spray paint is a generic possibility, although the coating is quite thin.

Potting the entire assembly in an insulator, room temperature vulcanising RTV silicone, achieves the same result. Immersing the assembly in oil or other insulating fluids is also effective. All of the potting and immersion techniques depend on removing the air or gas bubbles to be effective. Commercial manufacturers create a vacuum on the container while the assembly is being potted to facilitate the removal of the air bubbles.

An approach to reduce corona on wires is to surrounding the conductor by a semiconducting film or layer of greater radius. This effectively increases the radius of the object, and hence lowers the field strength. Minimal copper may be needed to carry the required current (often only milliamps), but a large diameter conductor is required to reduce the corona.

Field grading rings are often used on high voltage equipment to control the electric field distribution. Rather than rely the field that would exist in free space between two charged conductors, a series of other conductors are interposed at intermediate voltages. The intermediate voltages are derived from a capacitive or resistive divider. A capacitive divider may be as simple as the inter electrode capacitances of the grading rings themselves.

Running the system in a tank at high pressure, or in an insulating gas, increases the corona starting voltage.

33.19 Appendix: Contact metals

Table 33.16. Rare and precious metals used for mechanical contacts

Metal or alloy	Melting point (°C)	Vickers hardness (annealed)	Density (kg/m ³)	Resistivity at 20°C
<i>Light-duty contacts</i>				
Gold	1064	20	19 200	2.2
Platinum	1770	65	21 450	10.6
10% Iridium-platinum	1780	120	21 600	24.5
20% Iridium-platinum	1815	200	21 700	30.0
25% Iridium-platinum	1845	240	21 700	32.0
30% Iridium-platinum	1885	285	21 800	32.3
25% Iridium-ruthenium-platinum	1890	310	20 800	39.0
7% Platinum-silver-gold	1100	60	17 100	16.8
30% Silver-gold	1025	32	16 600	10.4
30% Silver-copper-gold	1014	95	14 400	14.0
10% Silver-copper-gold	861	160	13 700	12.5
Rhodium	1960	40	12 400	4.9
Iridium	2447	220	22 400	5.1
Palladium	1554	40	12 000	10.8
40% Silver-palladium	1290	95	11 900	35.8
40% Copper-palladium	1200	145	10 400	35.0
<i>Medium-duty contacts</i>				
10% Gold-silver	965	30	11 400	3.6
20% Palladium-silver	1070	55	10 700	10.1
10% Palladium-silver	1000	40	10 600	5.8
5% Palladium-silver	965	33	10 500	3.8
Fine silver	961	26	10 500	1.6
0.2% Magnesium-0.2% nickel-silver	961	140	10 400	2.8
1% Graphite-silver	961	40	9 900	1.8
2% Graphite-silver	961	40	9 700	2.0
Standard silver	778	56	10 300	1.9
10% Copper-silver	778	60	10 300	2.0
10% Cadmium oxide-silver	850	50	9 800	2.1
10% Nickel-silver	961	40	10 300	2.0
15% Cadmium oxide-silver	850	60	10 000	2.3
20% Copper-silver	778	85	10 200	2.1
20% Nickel-silver	961	48	10 100	2.1
Cadmium-copper-silver	800	65	10 100	4.2
50% Copper-silver	778	95	9 700	2.1
<i>Heavy-duty contacts</i>				
10% Cadmium oxide-silver	850	55	10 000	2.1
15% Cadmium oxide-silver	850	65	9 800	2.3
40% Tungsten carbide-silver	960	90	11 900	2.5
45% Tungsten carbide-silver	960	95	12 200	2.8
50% Tungsten-silver	960	125	13 600	2.8
50% Tungsten carbide-silver	960	160	12 500	3.0
55% Tungsten-silver	960	140	13 400	3.0
60% Tungsten carbide-silver	960	200	13 200	4.8
65% Tungsten-silver	960	185	14 800	3.3
73% Tungsten-silver	960	220	15 600	4.0
78% Tungsten-copper	1080	240	15 200	6.1
68% Tungsten-copper	1080	160	13 600	5.3
60% Tungsten-copper	1080	140	12 800	4.3

Reading list

<http://relays.tycoelectronics.com/>
<http://www.gigavac.com/>
<http://www.jenningstech.com/index.html>
http://www2.schneider-electric.com/corporate/en/products-services/technical-publications/breaking_page?
<http://www.pickeringrelay.com/highvoltage.html>
<http://www.wolfautomation.com/products/804/mercury-relayscontactors-30-to-100-ampbrmdi-mercury-relays>